

PACER
MASTER MACHINE INTERFACE DOCUMENTATION
FOR
3M M79

DOCUMENTATION RELEASE : 880106

MACHINE INFORMATION

MACHINE TYPE : 3M M79
REMOTES : NONE TESTED
MASTER LIMITATIONS : NONE
TIME CODE CHANNEL : ANY
HIGH SPEED CODE : NONE

TACH FEATURES

TACH Format : TACH + DIR
TACH Frequency : 32 Hz at 15 ips
Direction Signal : LOW = FORWARDS, HIGH = REVERSE
TACH Output Drive : OPTO SENSOR
TACH Pulse Shape : SQUARE

MACHINE MODIFICATION :

A-Sensor Installation

1. Lift deck and unscrew (Allen Type) the retaining bolt for the transport turnaround idler - remove assembly.
2. Remove cap of idler assembly and dismantle roller from mounting shaft.
3. To minimise slippage the idler should be sand blasted to break the gloss finish, in order to improve tape adhesion. Alternatively the idler can be replaced with a monothane coated idler now being supplied as standard by 3M.
4. After the above processing, select the reflective disc from the installation kit, peel off backing (do not bend disc), and fix to the bottom of the idler. Do not re-assemble the idler at this stage.
5. Remove the trim plates. Release the lifter spring from its centre spigot at the rear of the idler base position. Fit sensor assembly to machine and secure by replacing idler base on top of the sensor shim. Tighten the hex bolt of the idler base gently pulling it towards the front of the machine. Re-locate the lifter spring.
6. Remove the black deck plate by removing the two rear screws and then sliding the assembly back towards the VU panel. Feed the sensor cable through the deck casting to the rear of the machine. Do not replace the black deck plat at this time.
7. Re-assemble turnaround idler to mounting shaft and replace trim plates.

REMARKS

PACER MASTER

FUNCTION	'D' CONN-ECTOR	COLOUR
PACER 0V	1	RED
TACH REF	2	BLUE
TACH A	3	GREEN
TACH B or DIR	4	YELLOW
PACER +5V	5	
	6	
	7	
	8	
	9	
	SCREEN	

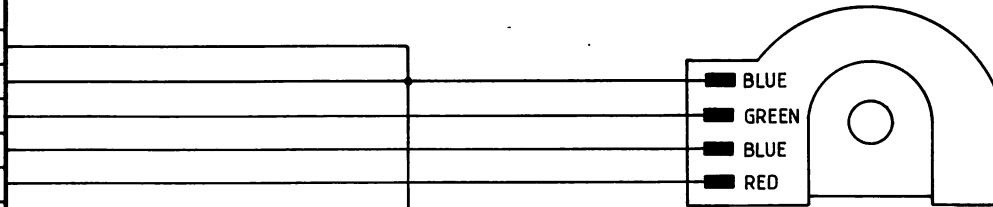

CONNECTOR SPECIFICATION	No. of WAYS	TYPE	LOCKING	CABLE SPECIFICATION	No. of WAYS	LENGTH
CONNECTOR 1	9	'D' PLUG	SCREW	CABLE 1	4	6M
CONNECTOR 2	4	PCB		CABLE 2		
CONNECTOR 3				CABLE 3		
CONNECTOR 4				CABLE 4		



AUDIO KINETICS (UK) LIMITED
 Kinetic Centre
 Theobald Street
 Borehamwood
 Hertfordshire WD6 4PJ
 England
 Telephone Number 01 953 8118

This drawing is the copyright of
 Audio Kinetics (UK) Limited and
 must not be copied or reproduced
 without our written permission.

MOD. No.	ISSUE	DATE	MOD. No.	ISSUE	DATE
			153	1	1.12.87

TITLE
**PACER MASTER CABLE FOR
 3M M79**

CERT'D.	CHECKED	DRAWN
	<i>S</i>	N.B./C.A.B.
DRAWING No. MPC 020		

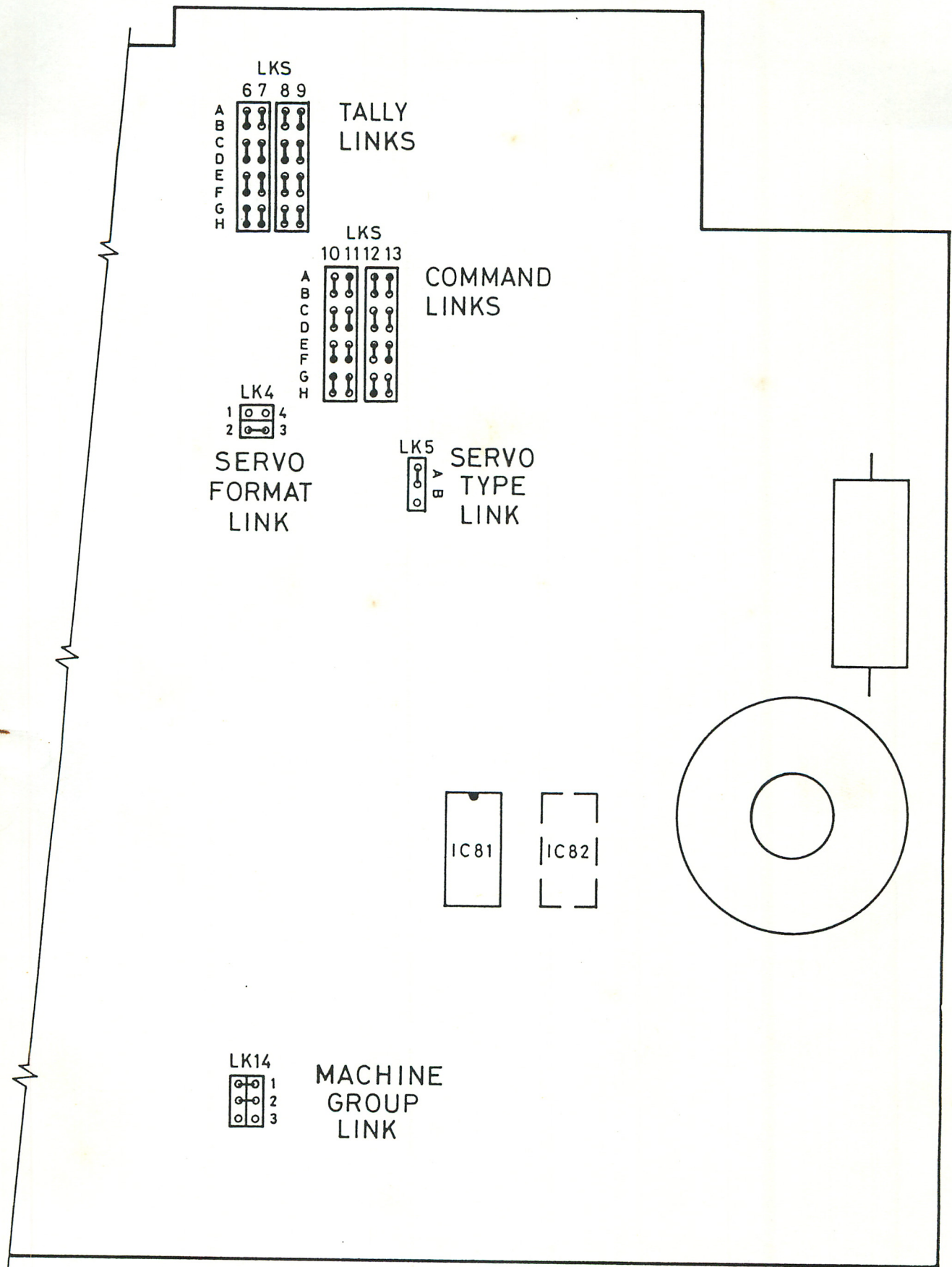

Figure 1

MODIFICATION	ISSUE	DATE	DRAWN	CHECKED	DRAWING NO.
	1	1.12.87.	NB/CAB		A4/QP/SPD /030



AUDIO KINETICS (UK) LIMITED
 Kinetic Centre
 Theobald Street
 Borehamwood
 Hertfordshire WD6 4PJ
 England
 Telephone Number 01 953 8118

TITLE
PACER MACHINE SPECIFIC LINK CONFIGURATION FOR 3M M79

©Copyright

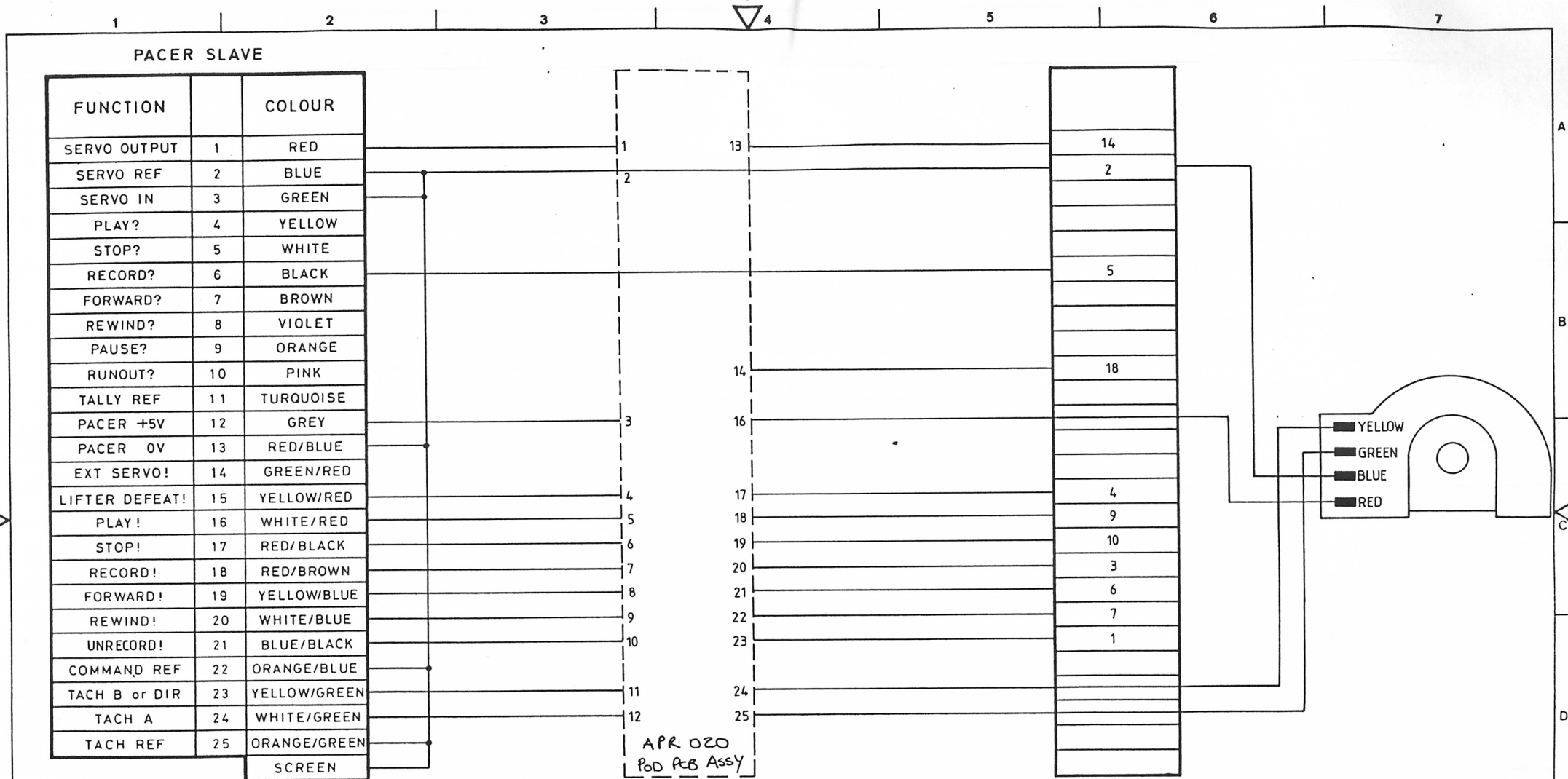

CONNECTOR SPECIFICATION	No. of WAYS	TYPE	LOCKING	CABLE SPECIFICATION	No. of WAYS	LENGTH
CONNECTOR 1	25	D PLUG	SCREW	CABLE 1	25	0.5m 6.0m
CONNECTOR 2	18	P.C.B. EDGE	SCREW	CABLE 2	25	0.5m 0.5m
CONNECTOR 3	4	P.C.B.	SCREW	CABLE 3	4	1M
CONNECTOR 4				CABLE 4		



AUDIO KINETICS (UK) LIMITED
 Kinetic Centre
 Theobald Street
 Borehamwood
 Hertfordshire WD6 4PJ
 England

This drawing is the copyright of Audio Kinetics (UK) Limited and must not be copied or reproduced without our written permission.

MOD No	ISSUE	DATE	MOD No	ISSUE	DATE
			157	1	1.12.87

TITLE
 PACER SLAVE CABLE FOR
 3M M79

CERT'D.
 CHECKED
 DRAWN NB/J.C.A.B.
 DRAWING No. SPC 020

PACER SLAVE

FUNCTION		COLOUR
SERVO OUTPUT	1	RED
SERVO REF	2	BLUE
SERVO IN	3	GREEN
PLAY?	4	YELLOW
STOP?	5	WHITE
RECORD?	6	BLACK
FORWARD?	7	BROWN
REWIND?	8	VIOLET
PAUSE?	9	ORANGE
RUNOUT?	10	PINK
TALLY REF	11	TURQUOISE
PACER +5V	12	GREY
PACER 0V	13	RED/BLUE
EXT SERVO!	14	GREEN/RED
LIFTER DEFEAT!	15	YELLOW/RED
PLAY!	16	WHITE/RED
STOP!	17	RED/BLACK
RECORD!	18	RED/BROWN
FORWARD!	19	YELLOW/BLUE
REWIND!	20	WHITE/BLUE
UNRECORD!	21	BLUE/BLACK
COMMAND REF	22	ORANGE/BLUE
TACH B or DIR	23	YELLOW/GREEN
TACH A	24	WHITE/GREEN
TACH REF	25	ORANGE/GREEN
SCREEN		

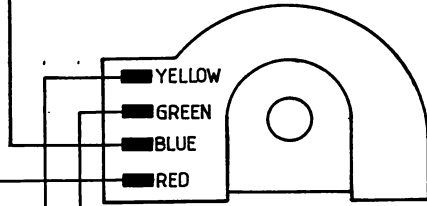
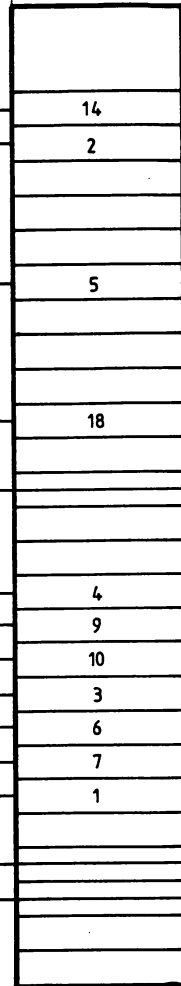

CONNECTOR 1

CABLE 1

CABLE 2

CONNECTOR 2

CABLE 3

CONNECTOR SPECIFICATION	No. of WAYS	TYPE	LOCKING	CABLE SPECIFICATION	No. of WAYS	LENGTH
CONNECTOR 1	25	D PLUG	SCREW	CABLE 1	25	6.0 m
CONNECTOR 2	18	P.C.B. EDGE	SCREW	CABLE 2	25	0.5 m
CONNECTOR 3	4	P.C.B.	SCREW	CABLE 3	4	1 M
CONNECTOR 4				CABLE 4		

NOTE: POLARISING KEY BETWEEN PINS 15 & 16



AUDIO KINETICS (UK) LIMITED
Kinetic Centre
Theobald Street
Borehamwood
Hertfordshire WD6 4PJ
England
Telephone Number 01 933 8118



This drawing is the copyright of Audio Kinetics (UK) Limited and must not be copied or reproduced without our written permission.

MOD. No.	ISSUE	DATE	MOD. No.	ISSUE	DATE
			417	2	3-3-88
			157	1	1.12.87

TITLE
PACER SLAVE CABLE FOR
3M M79

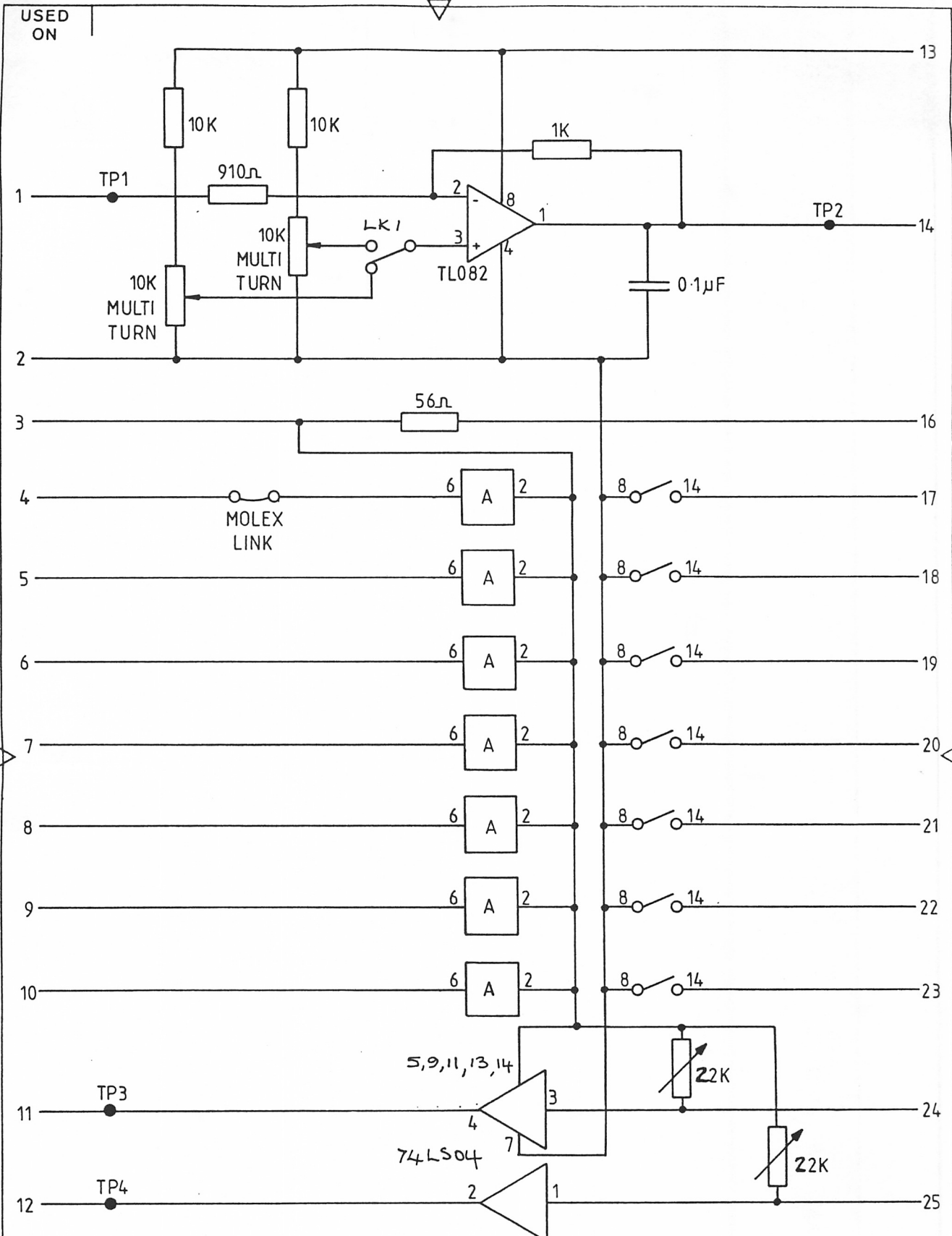
CERT'D.	CHECKED	DRAWN
		NB/C.A.B.
DRAWING No. SPC 020		



CERT'D.	 AUDIO KINETICS (UK) LIMITED Kinetic Centre Theobald Street Borehamwood Hertfordshire WD9 3PF England Telephone Number 01923 211111	157	1	1.12.87
CHECKED		MOD. No.	ISSUE	DATE
 DRAWN N.B./C.A.B	This drawing is the copyright of Audio Kinetics (UK) Limited and must not be copied or reproduced without our written permission.	TITLE POD BOARD FOR 3M M79 CABLE		
		DRAWING No. APR 520		

ATTENTION

Some Pacer machine cables have the same
connector at both ends.

Please note that all Pacer cables have a label
consisting of a cable part number at the end which
you should connect to the rear of PACER

Please ensure that you connect it
the right way round !