

STW

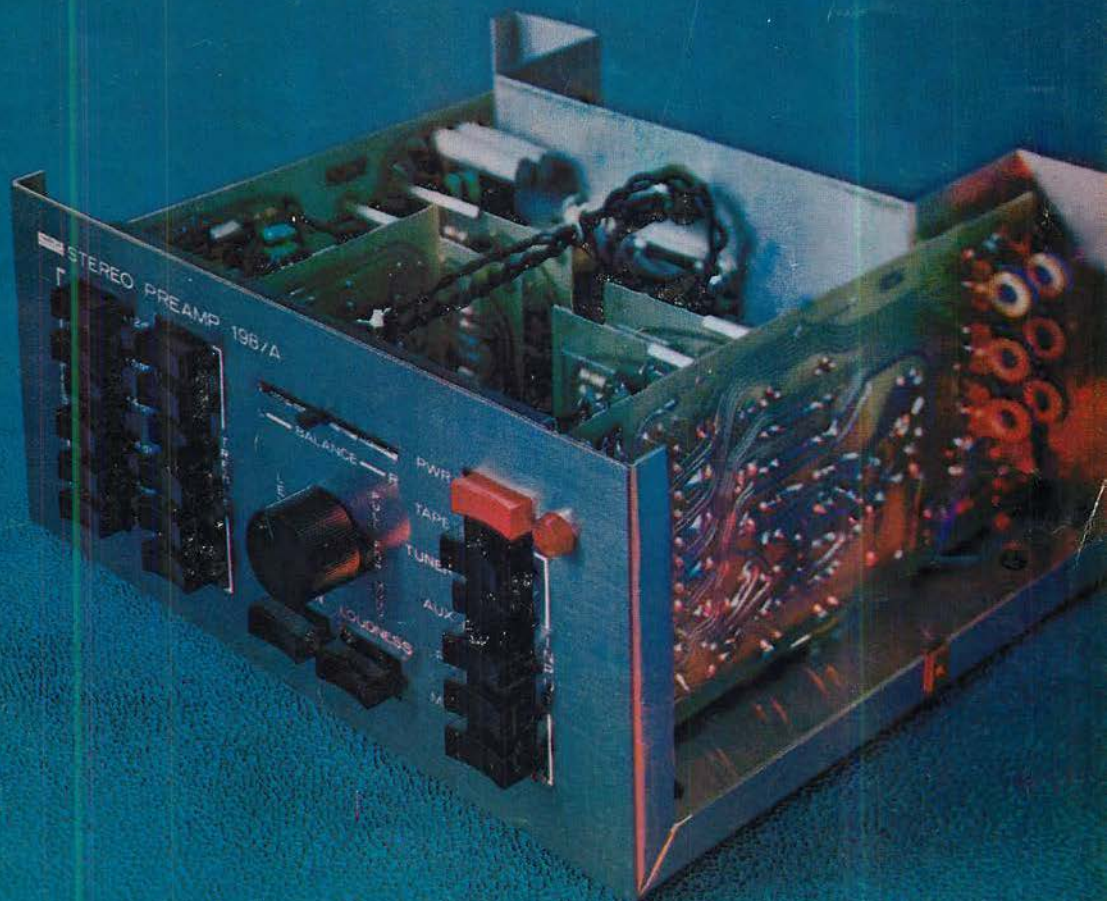

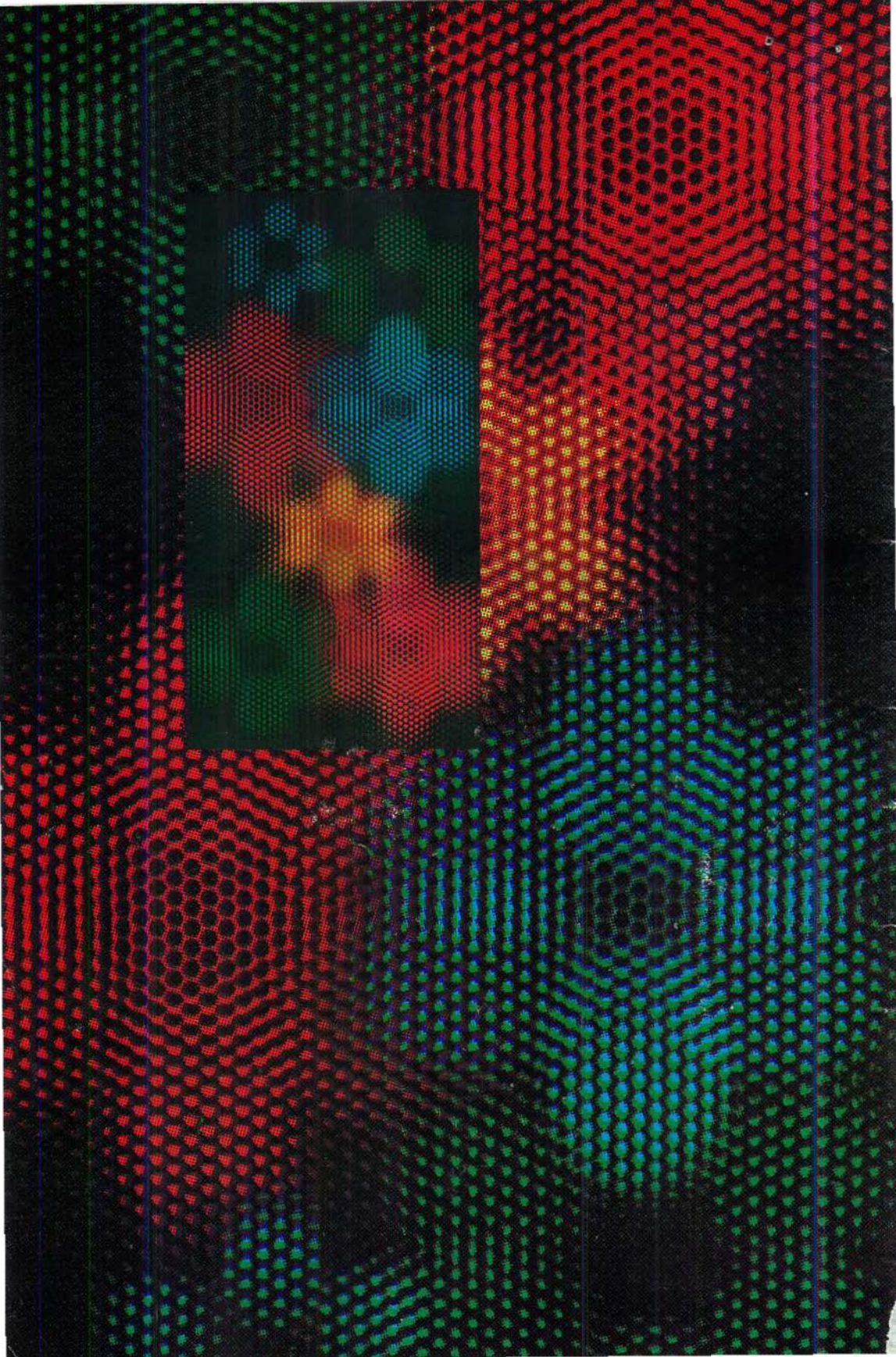

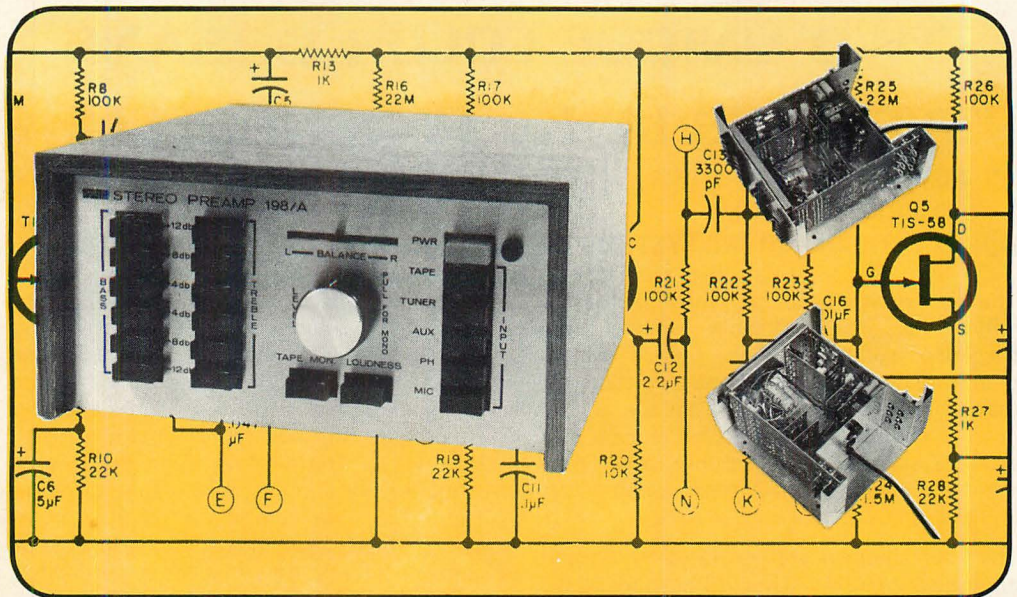

198/A PREAMP

PUSHBUTTON TONE CONTROLS
GAIN MODULE DESIGN
MOTHERBOARD CONSTRUCTION
SELF POWERED – WILL
WORK WITH ANY AMPLIFIER

We are proud to offer a preamp and control center that is equal in quality and performance to our new "Tiger .01" amplifier. Both input and tone control settings are push-button switch selected. This makes it possible to get the exact amount of compensation you want every time, just as in

professional studio equipment. When no compensation is wanted the amplification is absolutely flat.

All controls have been designed to make their function as obvious as possible, so that the chances of a mistake in settings will be minimized. Loudness compensation and tape monitor functions are provided.

All gain needed is provided by four of our plug-in #195 opamp circuits. These plug into two "motherboards" that contain all the switching and equalization components. The result is vastly simplified wiring, and easy construction.

The kit is complete with a brushed gold finished front panel and the wood grain finished cover shown. Two switched convenience AC receptacles are provided on the back.

#198A Preamp Kit, 6 lbs. . . . \$69.50 + postage

SPECIFICATIONS

Sensitivity..... Phono and Mic 2.0 mv for 1 Volt output, All Others 100 mv. for 1 Volt output
 Frequency Response..... Flat \pm 1 db 10 to 100,000 Cycles
 Distortion..... Less than .05% Harmonic or IM at rated output
 Noise..... Phono and Mic 65 db down all others 70 db down

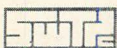

Southwest Technical Products Corporation, 219 W. Rhapsody, San Antonio, Texas

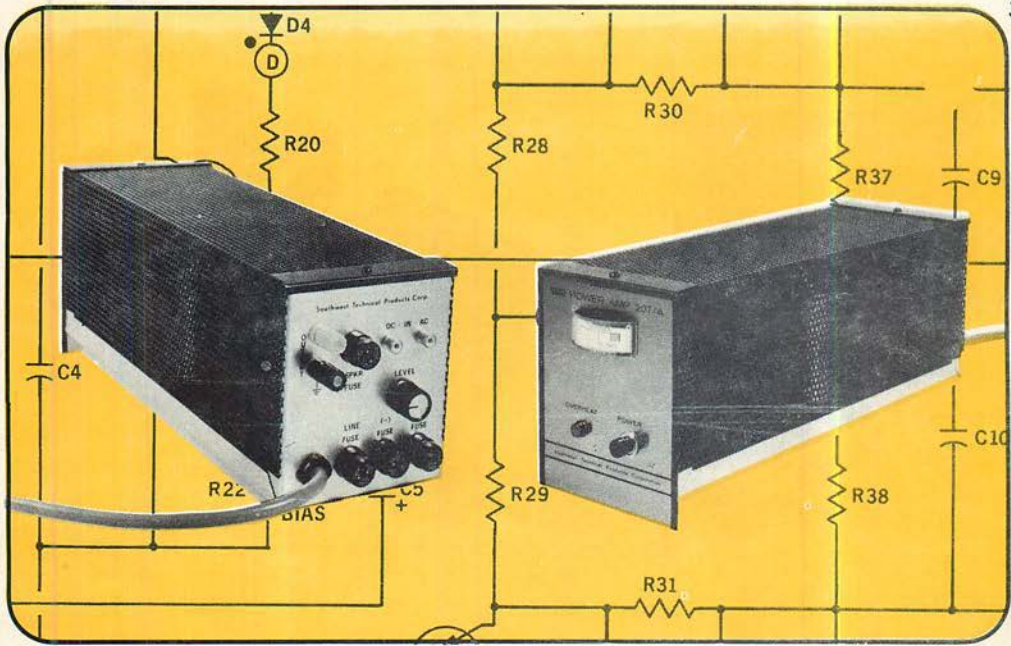

TIGER .01

A new standard of performance. We know of no amplifier now available that can match the performance of our new "Tiger .01". Our new completely push-pull circuit with cross coupled push-pull feedback makes possible an IM distortion rating of less than .01% up to rated output. This is easily ten to one hundred times better than many so called Hi-Fi amplifiers. The distortion is so low that presently available instruments cannot accurately measure it. This is the first amplifier that we have ever measured that has lower IM distortion than harmonic distortion. IM distortion is generally recognized as correlating better with listening tests than any other measurement of performance.

The amplifier is designed to be used as either a single channel unit for sound system and

instruments, or in any multiple needed for stereo or quad systems. Optional wood grain finish cabinets are available for mounting two, or four of these amplifiers. The front panel is quarter rack size to allow relay rack mounting of up to four of these units in a standard 19 inch relay rack.

The circuit features volt-amp and fuse protection, plus an over heat thermostat. An output meter is provided on the front panel as shown. The perforated metal cover is included in the standard kit.

- # 207 Complete Kit \$75.00
shipping weight 15 pounds
- # 207-A Assembled Amplifier \$105.00
shipping weight 15 pounds

SPECIFICATIONS

Power Output.....	60 Watts RMS
IM Distortion.....	less than .01%
Harmonic Distortion.....	.03%
Input Impedance.....	50K Ohms
Damping Factor.....	greater than 100 with 8 Ohm load 20-20,000 Hz.
Sensitivity.....	1.0 Volt for full Output
Hum and Noise.....	More than 80 db below 10Watts
Bandwidth.....	-1 db 10 Hz and 250,000 Hz.

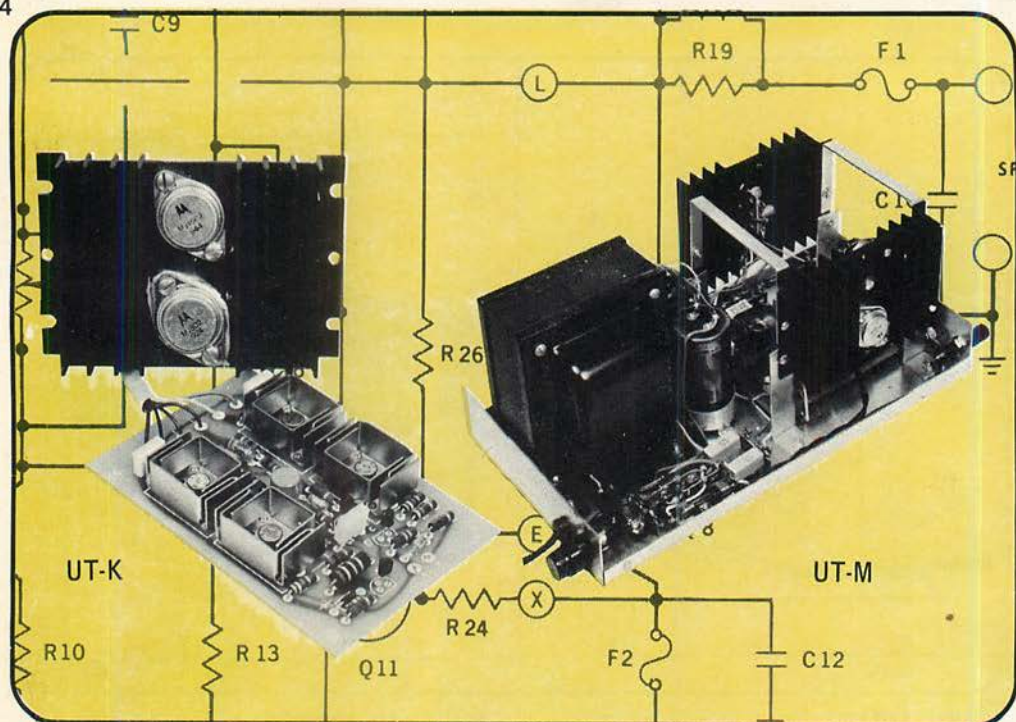

UNIVERSAL TIGER MK II

Our all purpose, rugged, old standby for almost any type audio application. The "Universal Tiger" is clean enough for the best stereo and hi-fi applications and also powerful enough to be used for PA, organs and sound systems of all types. Total harmonic distortion is typically less than .05% at full rated power and IM distortion less than .2%.

The circuit features a differential amplifier input stage, current source driver and full complementary output stage. The circuit is protected with a volt-amp limiting system, speaker fuses and drive limiting. Two large heat sinks and open construction insure cool reliable operation.

This kit has step-by-step assembly instructions and pictorial assembly drawings to make

construction as easy as possible. As usual, nothing but the best parts and fiberglass circuit boards are used in the kit.

For those building custom systems, or those who may have a suitable power supply on hand already, we offer a "basic" kit, our UT-K. This consists of the circuit board and parts, plus the heat sink (1) and output transistors. This is the ultimate in economy if you enjoy building from "scratch", and have the other odds and ends needed to complete the amplifier.

UT-K	Kit (left picture) -	
Shipping Weight	3.6 lbs.	\$30.00
UT-M	Single Channel Kit (right picture)	11x6x5-
Shipping Weight	14 lbs.	\$60.00
2UT-M	Two Channels -	
Shipping Weight	28 lbs.	\$115.00
UT-MA	Assembled and tested -	
Shipping Weight	14 lbs.	\$90.00
2UT-MA	Two Channels Assembled and tested -	
Shipping Weight	28 lbs.	\$175.00

SPECIFICATIONS

Power Output	90 Watts	— 8 Ohm load
	100 Watts	— 4 Ohm load
Total Harmonic Distortion	.05%	
Input Impedance	20,000 Ohms	
Damping Factor	Over 100 with 8 Ohm load	
Sensitivity	1.5 Volts RMS for full Output	
Hum and Noise	More than 80 db below 10 Watts	
Bandwidth	3.0 db down at 0.5 and 250 KHz	
IM Distortion	less than 0.2%	



Southwest Technical Products Corporation, 219 W. Rhapsody, San Antonio, Texas

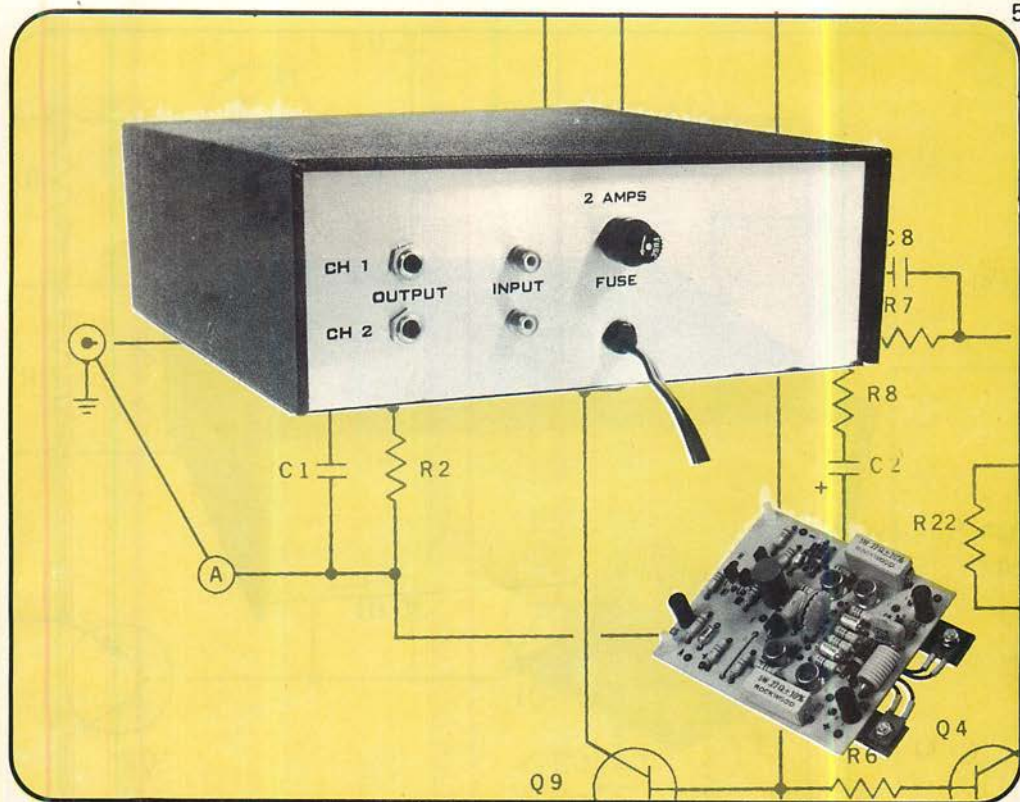

Pictorial assembly drawing and step by step instructions make this kit an easy project for anyone with even an elementary knowledge of electronic construction.

- # 185 "Plastic Tiger" kit - circuit board and parts for one channel only.- 6 oz. **\$18.50**
- # 185-C Complete Stereo Amplifier - consists of two 185 kits as above plus chassis and power supply as shown.- 8 lbs. **\$55.00**
- # 185-CA Assembled Stereo Amplifier-8 lb.. **\$75.00**

PLASTIC TIGER

"Plastic Tiger" is the answer for those who want a really good amplifier in the medium power range. It uses the same superior circuit as the "Universal Tiger", but with economical plastic output transistors. Total harmonic distortion is typically below 0.1% up to full rated output.

Compare the specifications of this amplifier with any other amplifier offered in this power range.

Plastic Tiger is available, as shown above, as just an amplifier, or complete with power supply and chassis. The chassis has brushed red-gold trim panels on the front and rear and a textured black vinyl covered top.

SPECIFICATIONS

Power Output	Either Channel Singly: 36 Watts RMS-8 Ohm load 40 Watt IHFM-8 Ohm load
	Both Channels Driven: 30 Watts RMS-8 Ohm load
Total Harmonic Distortion....	Less than 0.1% up to rated output
Input Impedance	22 K Ohms
Output	Less than .25 Ohms 20-20,000 Hz
Sensitivity.....	1.25 Volts RMS input for 30 Watts output
Hum & Noise	More than 80 db below 10 Watts — less than 1.0 Mv at output
Frequency Response	1.0 db down at 5 and 100,000 cycles
	3 db down at 2 and 150,000 cycles
Stability.....	Unconditionally stable with any type load impedance, or input impedance.
Protection	Current into shorted load limited by inherent characteristics of circuit

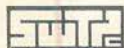

Southwest Technical Products Corporation, 219 W. Rhapsody, San Antonio, Texas

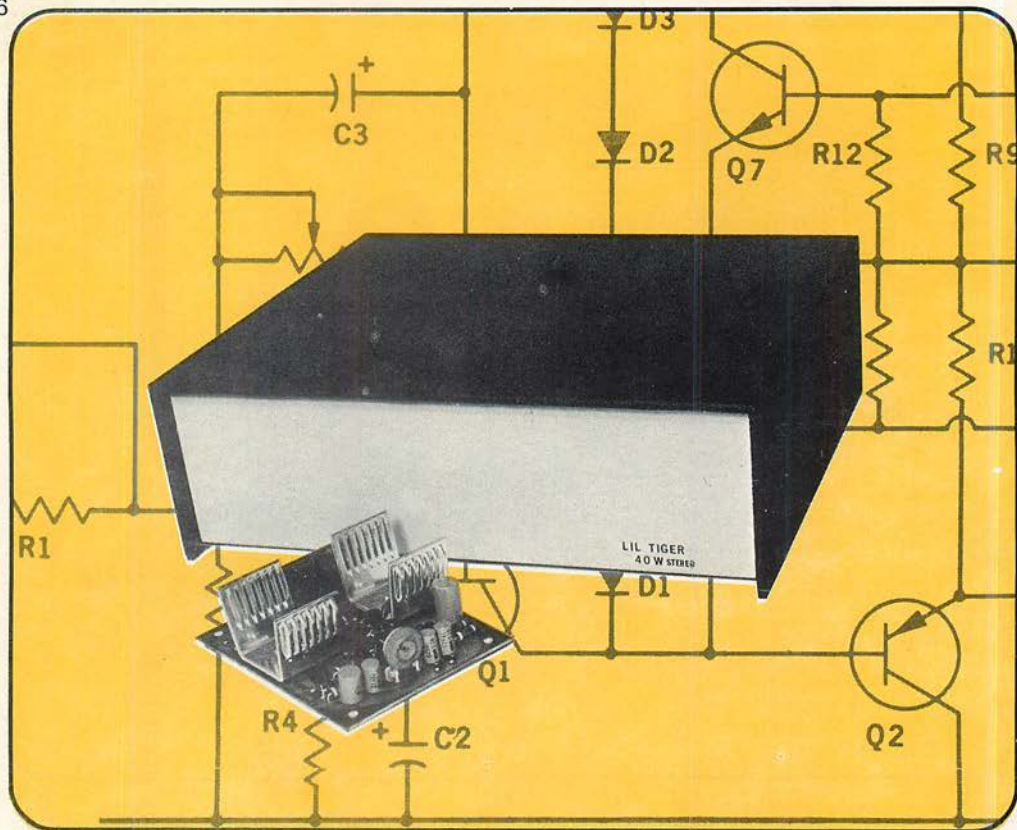

This fantastic little amplifier has been built by thousands of people since it was introduced over three years ago. There is still nothing that can compare with this amplifier in its price range. Quality parts and circuit boards, plus the new brushed gold front panel make this amplifier a real "best buy".

# 140-CX	Lil Tiger Amplifier -	
	Shipping Weight 6 oz.	\$11.10
# P-140	Power Supply and Chassis -	
	Shipping Weight 6 lbs.	\$15.00
	Complete Stereo Amplifier Kit (consisting of 2	
	# 140-CX and P-140).....	\$37.00

SPECIFICATIONS

Power Output	18 Watts RMS .22 Watts IHFM
	per channel into an 8.0-Ohm load with
	45-Volt power supply
Distortion	Less than 1% total harmonic up
	to a full rated output
Frequency Response.....	3db down at 20 Hz and
	100,000 Hz
Input Impedance.....	Approximately 5000 Ohms
Output Impedance.....	Approximately 0.1 Ohm
	(damping factor of 80 with 8-Ohm load)
Hum and Noise ...	More than 80 db below one Watt
Sensitivity	1.5-Volt input for 20 Watt output
Supply Voltage	12 to 45 Volts d.c.

LIL TIGER

ALL SILICON TRANSISTOR CIRCUIT
 OUTPUT SHORT PROTECTION
 COMPLEMENTARY OUTPUT STAGE
 FIBERGLASS CIRCUIT BOARD

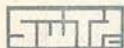

Southwest Technical Products Corporation, 219 W. Rhapsody, San Antonio, Texas

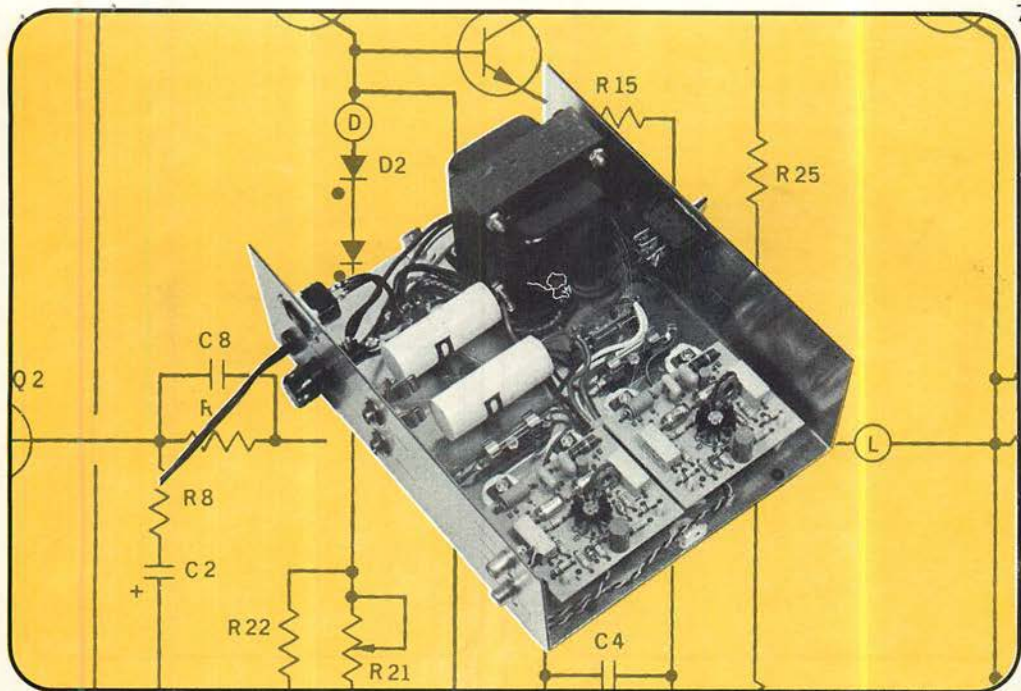

This produces an outstanding amplifier value. Total harmonic distortion is typically around 0.1% at levels below 1 Watt and reaches 1% just before clipping level. The 31 transistor circuit in the IC driver features differential amplifier input and Volt-Amp protection of the output circuit. Only with an integrated circuit could all these features be included at this price.

The chassis trim panels are brushed Red-Gold and the top is covered with textured black vinyl. As always the circuit boards are of fiberglass and only quality parts are supplied in the kit. "540" is supplied with pictorial and step by step instructions. Can easily be assembled by anyone who has learned how to solder.

540

NEW - POWER DRIVER IC DESIGN

VOLT-AMP PROTECTION CIRCUIT

**COMPLIMENTARY OUTPUT
TRANSISTORS**

"540" is a new direction in power amplifier design. The entire circuit consists of the new 540 Power Driver integrated circuit and two big husky 10 Amp complementary power transistors.

"540" Amplifier kit - one channel - board and parts only - 6 oz. \$10.50
"540-C" Complete Stereo Amplifier - consists of two "540" kits as above and chassis with power supply shown - 6.0 lbs..... \$37.50

SPECIFICATIONS

Power Output 20 Watts IHFM
18 Watts RMS-one channel
15 Watts RMS-both driven
Distortion Less than 1% total harmonic at full output. Less than 2% at levels below 1 Watt
Frequency Response 1 db down at 5 and 100,000 Hz
Hum and Noise.... More than 80 db below 10 Watt
Sensitivity..... .4 Volt RMS for full output

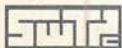

Southwest Technical Products Corporation, 219 W. Rhapsody, San Antonio, Texas

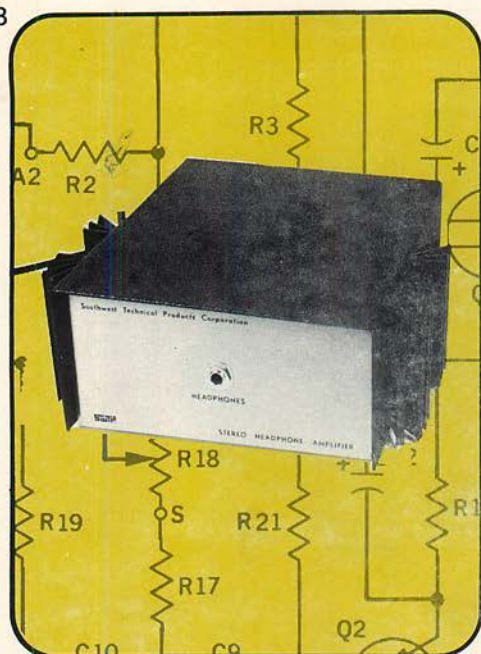

HEADSET AMPLIFIER

DESIGNED SPECIFICALLY TO DRIVE
HEADSETS

CLASS A OPERATION - LOW
DISTORTION AT ANY LEVEL

FLAT + 0.5 DB 10 to 100,000 Hz

At last an amplifier designed specifically for driving a headset. This amplifier has all of the features found in the best power amplifiers, but provides a power output suitable for driving headsets safely. This amplifier will deliver 2 Watts per channel of ultra clean class A power with a damping factor greater than 20 into an 8 - 16 Ohm headset.

Construction is easy. All parts except transformers and connection jacks mount on two of our fiberglass circuit boards. The 7x8x3½ deep case is finished in a beautiful new dusky chrome and has a black vinyl covered steel top.

202-C Headset Amplifier Kit -

Shipping Weight 7 lbs. \$44.50

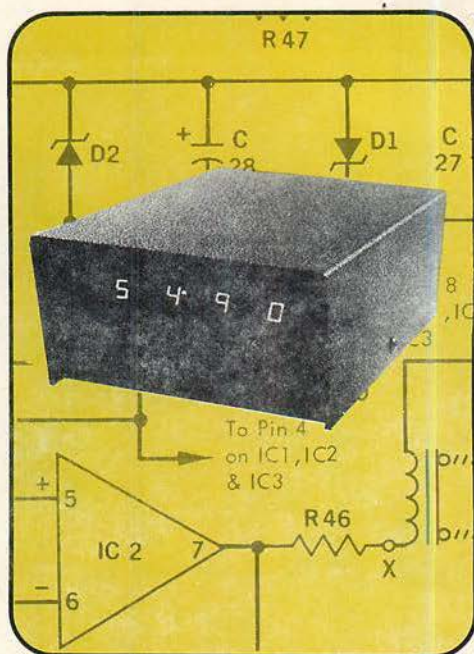

DIGITAL TACHOMETER

400 to 9,990 RPM WITH NO RANGE
CHANGING

4 DIGIT LED READOUT

WORKS WITH 4, 6 OR 8 CYLINDER
ENGINES

Our high accuracy digital readout tachometer. This instrument measures your engines RPM ten times a second and displays it on four bright red 0.3 inch high LED readouts.

Only three wire connections in the whole kit. The Tachometer is housed in an attractive black vinyl covered aluminum box 4½ wide by 2½ high by 7 inches deep. May be mounted on top of, or under the dash in your car. Simple hookup - only +12 volts, ground and distributor point connections are needed.

TACH-1 Kit. Shipping weight 3.0 lbs. \$79.50

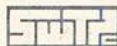

Southwest Technical Products Corporation, 219 W. Rhapsody, San Antonio, Texas

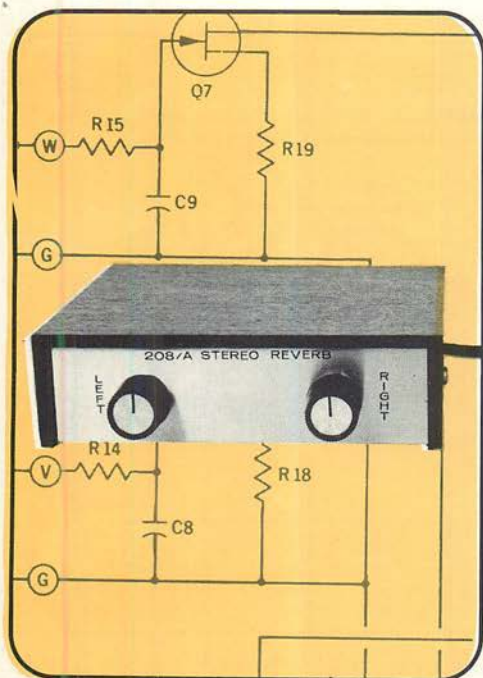

REVERB ADAPTOR

Use our new self powered stereo reverb adaptor to put reverberation into your system. The spring reverb unit adds the "Concert hall" reverberation time to your music electronically. Simulates the acoustics of a large hall and gives your music more "life."

Two independent channels with separate controls to add the exact amount of reverb you prefer in each stereo channel. This self-powered unit is connected between your preamp and power amplifier and may be used with any type system.

Brushed gold chassis with wood grain cover. Step-by-step instruction and use of three integrated circuits make this kit quick and easy to assemble.

- # 239-C Complete Kit with two spring units ---
5½ lbs. **\$38.50**
- # Z-1C Reverb Springs only as used in above
kit. 2,000 Ohm input and output. ---
2.0 lbs. each **\$10.00**

SPECIFICATIONS

Nominal Delay	37 Milliseconds
Reverberation	0.50%-Control on panel
Size.....	5 x 5 x ¼

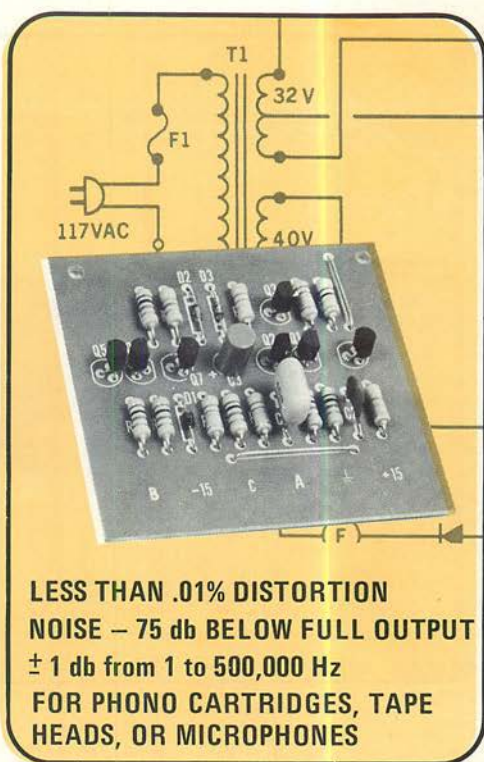

LESS THAN .01% DISTORTION
NOISE - 75 db BELOW FULL OUTPUT
 ± 1 db from 1 to 500,000 Hz
FOR PHONO CARTRIDGES, TAPE HEADS, OR MICROPHONES

195 PREAMP

We are happy to be able to offer a really outstanding preamp module for those who enjoy building up their own systems. The # 195 preamp is designed using integrated circuit techniques, but by using discrete components much better characteristics are obtained. It is impossible to get really superior noise figures in an IC preamplifier due to the processing steps that are required, each of which tends to add noise. It is also impossible to get precise resistor values and difficult to make both NPN and PNP transistors on the same chip. Our seven transistor circuit is a basic op-amp type system. You add the equalization needed for your application, just as you would with an IC' op-amp module. The 3 x 3 fiberglass circuit board is designed so that it may be wired, or plugged into PC edge connectors. Distortion is less than .01% at any audio frequency. Suggested power supply is ± 15 Volts DC @ 10 Ma. which may be obtained from any of our power amplifiers except # 140. Separate supply available.

- #195 Preamp Kit
 Shipping Weight 8 oz. **\$9.75**



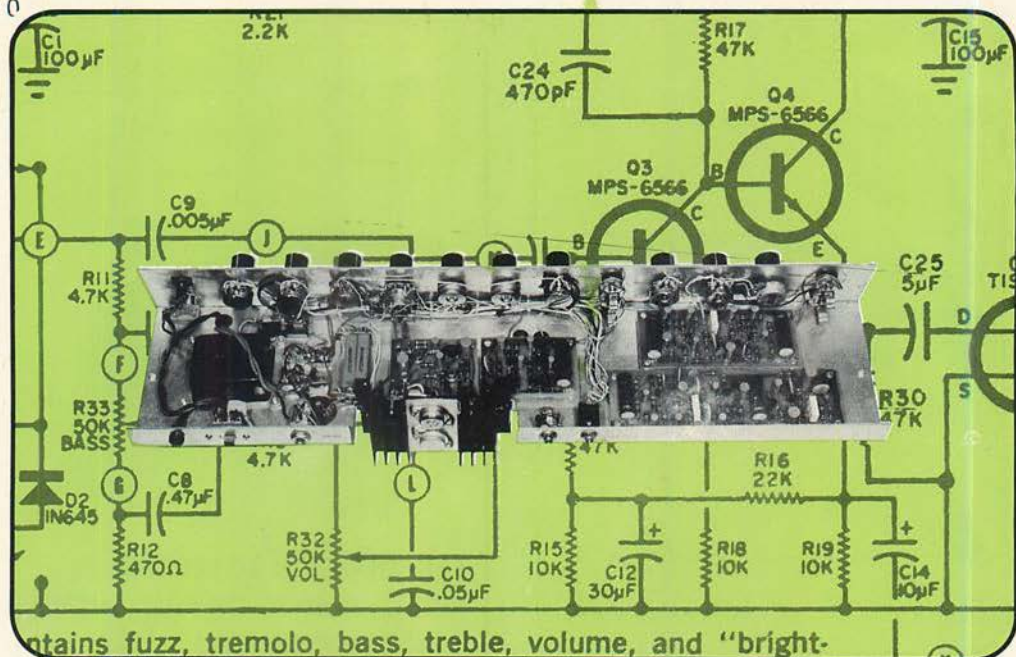

contains fuzz, tremolo, bass, treble, volume, and "bright-

M/M/M INSTRUMENT AMPLIFIER

TREMOLO REVERB AND FUZZ

FOOT SWITCH CONTROL OF
TREMOLO AND REVERB

FET INPUT STAGE FOR QUIET
OPERATION

60 WATT RMS OUTPUT
150 WATTS PEAK

Time tested by professional combo groups, this instrument amplifier can't be touched by any similar professional unit as far as price, quality and versatility are concerned. A complete custom sound system can be purchased for your electric guitar or other type stringed instrument. If you already have some type of system for your instrument, then special sections can be added for desired effects. Custom fit your instrument as to your needs. This versatile system includes controllable fuzz, tremolo, and reverb; also, a clean 60-Watt booster. A straight preamplifier for vocal or voice announcements can also be added. Now being supplied with short proof output circuit. No more blown transistors from accidentally shorted speaker leads.

FET INPUT STAGE
SHORT PROTECTED AMPLIFIER
PICTORIAL ASSEMBLY INSTRUCTIONS
BRUSHED FINISH FRONT PANEL

MMM Complete Amplifier, less cabinet, with reverb and both preamps - Amplifier cabinet size: 24½x9x7½"
Shipping Weight 13 lbs. \$90.00
(Prices of amplifier, preamp and reverb sections as separate items available on request.)

SPECIFICATIONS

Power Output 60 Watts RMS
150 Watts Peak Power
Frequency Response 20 Hz to 50 KHz
Dynamic Range 60 db without overloading
Complete control of Fuzz, Tremolo and Reverb



Southwest Technical Products Corporation, 219 W. Rhapsody, San Antonio, Texas

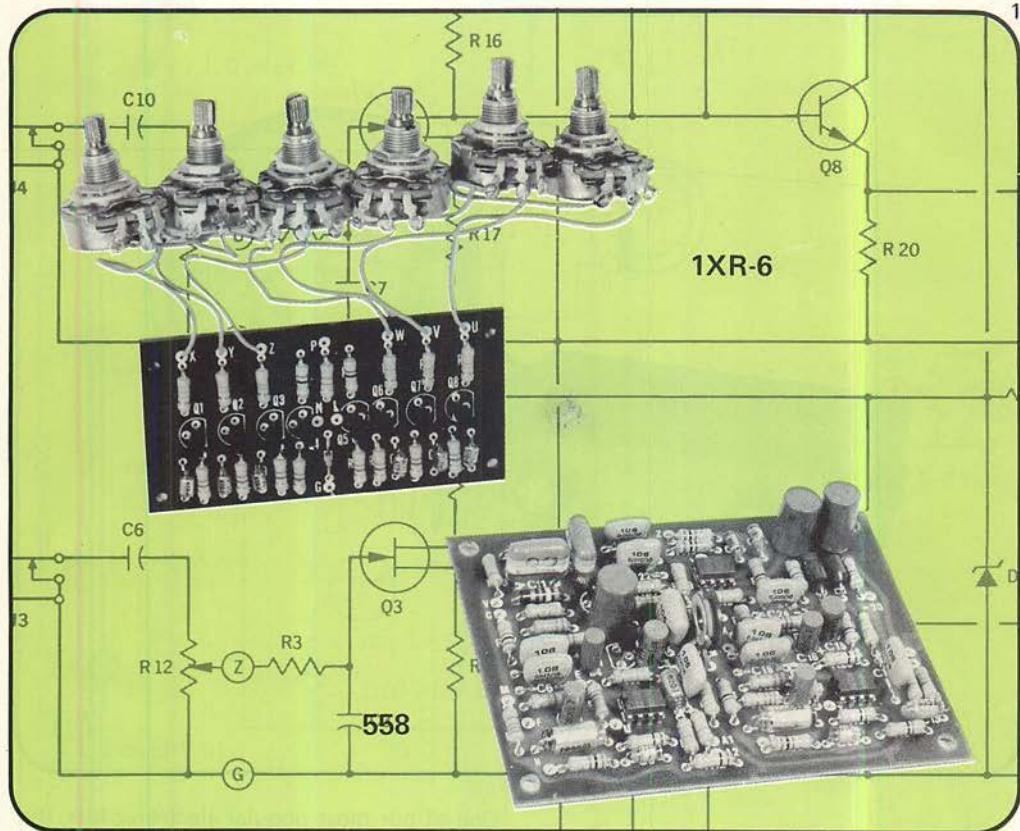

DUAL CHANNEL PREAMP 558

One straight preamp with only tone controls, one preamp with tremolo and reverb. All on $3\frac{1}{4} \times 4\frac{1}{2}$ circuit board. New op-amp circuit provides all these features and less than 0.1% distortion at 1.0 Volt output. Combine with one of our "Tiger" series, or 540 amplifiers for a complete system.

The circuit features the "558" dual op-amp integrated circuit, for consistent stable operation. Tremolo is controlled by a FET transistor for the cleanest smoothest modulation you have ever heard.

Kit is complete with all controls (9) but less the reverb spring.—("O.C." Z-1B. suggested)

'558' Preamp Kit - Shipping Weight 1 lb. . \$27.85
Reverb Spring - Shipping Weight 2 lbs. \$10.00

6 INPUT MIXER

For those custom PA designs — Two channels with three inputs on each channel, or six inputs to one channel as needed. An individual FET high impedance input stage is used with individual volume controls for each input. The mixer cannot cause loading, or add noise to your system. Inputs of up to 0.5 Volts RMS may be used without overloading. Circuit gain of 3 in two channel, or unity if used on one channel allows addition of the mixer at almost any point in your system from the microphone to the power amplifier. Requires 12 to 24 Volts DC at 5 Ma. Complete with controls.

1xr-6 Kit - Shipping Weight 1 lb. \$13.75



Southwest Technical Products Corporation, 219 W. Rhapsody, San Antonio, Texas

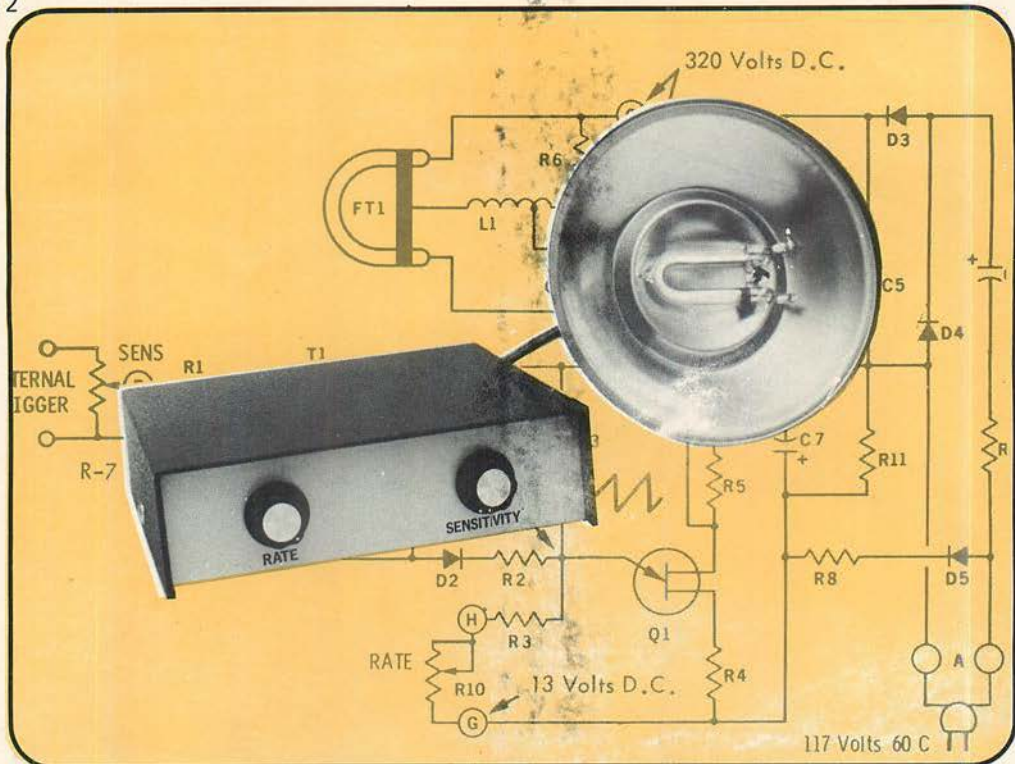

PSYCHEDELIC STROBE LIGHT

WIDE RANGE OF FLASH RATES

FLASH HEAD REMOTE FROM CONTROL BOX

INPUT PROVIDED TO SYNCHRONIZE FLASHES WITH YOUR MUSIC

One of our most popular electronic kits, the Strobe Light, will delight adults as well as the "teen-scene". Aside from practical uses in photography and general purpose stop-motion observation, this psychedelic strobe light can create the most unusual effects seen with musical groups or "at home" parties. The strobe flashing at a proper rate synchronized with the music in a semi-darkened room produces an illusory and bizarre scene. It reminds one of the old time "flicks" and "The Keystone Kops". Musical groups need not limit their purchase to just one strobe. Experiment with several - The effect is incredible.

The punched cabinet is chrome plated. Top covering is textured black vinyl. Cabinet matches Sonolite Color organ. Polished 5½" reflector.

"Medical opinion concerning the use of strobe lighting in darkened rooms is 'cautionary'. Prolonged use may induce hallucinations or trigger undesired side-effects. It should not be used in the presence of anyone subject to epilepsy."

X-149C Psychedelic Strobe Kit.
Shipping Weight 2 lbs. \$17.50
X-149A Assembled Psychedelic Strobe
Shipping Weight 2 lbs. \$29.95



Southwest Technical Products Corporation, 219 W. Rhapsody, San Antonio, Texas

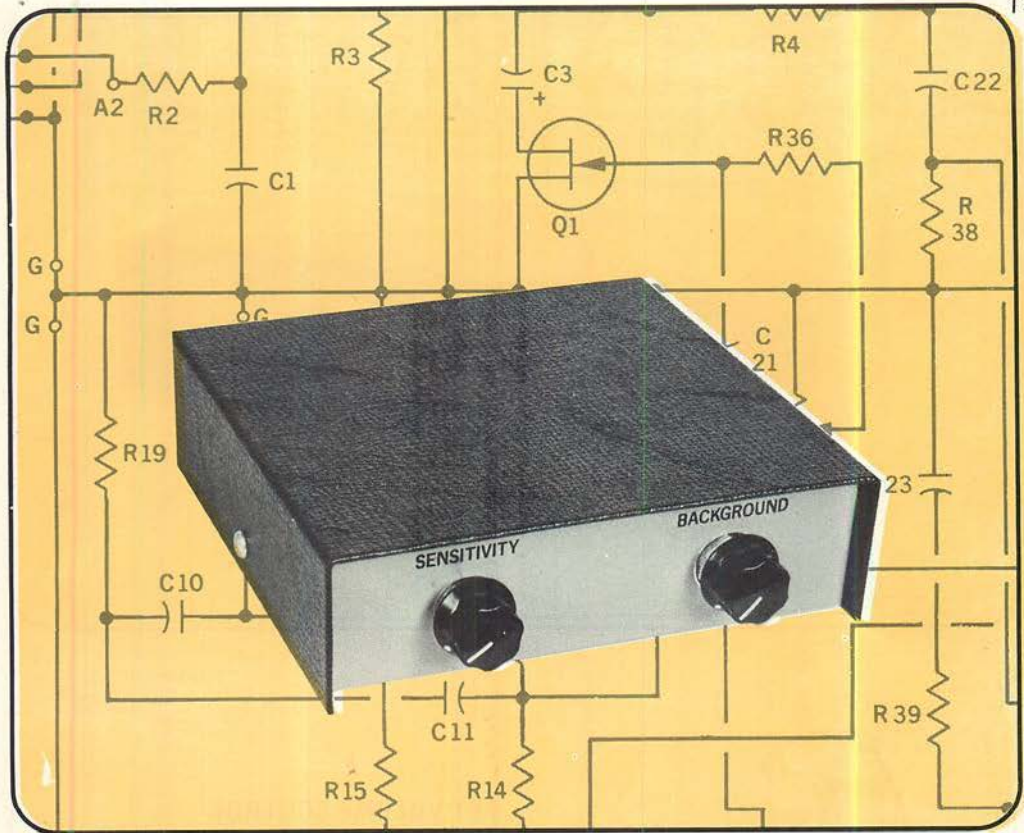

Simplified Construction - With Pictorial Wiring Diagrams - Higher Power - Now 8 Amps RMS

Although inexpensive, the Sonolite features a full wave "Triac" control system. The input system is completely isolated from the power control section by a lamp-Photocell assembly. No danger of blown fuses, or shocks. This versatile circuit can also be used as a motor speed control, lamp dimmer, or as a remote power control system. Use a "Sonolite" with each amplifier in your musical group to produce a light show with music. The high power control rating of the Sonolite makes it possible to operate several floodlamps from each unit.

X147C Kit - Sonolite Color Organ -
Shipping Weight 2 lbs. \$11.00
147 Assembled - Sonolite Color Organ -
Shipping Weight 2 lbs. \$16.50

SPECIFICATIONS

Controlled Power 800 Watts
Input Power - (Full Output)5 Watt
Input Impedance 8 or 16 Ohms
Controls Background Sensitivity Size 5x5x1½

SONOLITE- COLOR ORGAN

USE WITH ANY MUSIC SYSTEM
CONTROLS UP TO 800 WATTS
EASY TO INSTALL

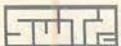

Southwest Technical Products Corporation, 219 W. Rhapsody, San Antonio, Texas

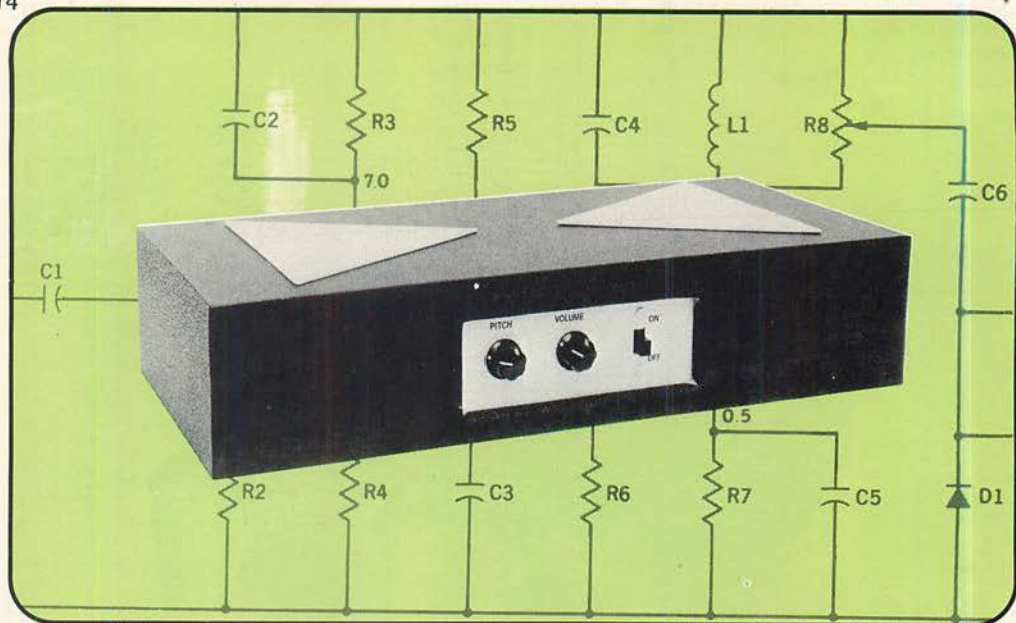

THEREMIN ELECTRONIC MUSICAL INSTRUMENT

**FET VOLUME CONTROL
USE WITH ANY INSTRUMENT
VINYL COVERED CABINET -
MATCHES INSTRUMENT AMPLIFIER
POWERED BY 9 VOLT BATTERY**

A modern, solid state version of the Theremin all electronic musical instrument. Two antenna plates, operated by hand capacity, control the pitch and volume of the sound. Add this to your combo for a really unique and different sound.

Our revised version of this instrument now has fully shielded coils and a new tuning circuit. Adjustments are fast and noncritical. The rugged vinyl covered cabinet matches our MMM Instrument amplifier.

142 Complete kit for Theremin - with cabinet & Antenna - Shipping Weight 4 lbs. \$22.50
TE Theremin-electronics kit only (no case) - Shipping Weight 9 oz. \$16.50

SPECIFICATIONS

Controls Pitch - Zero set - Volume
Approximate Sound Range..... 30 to 15,000 Cycles
Volume Range 50 to 60 db Change
Power Internal 9 Volt Battery



Southwest Technical Products Corporation, 219 W. Rhapsody, San Antonio, Texas

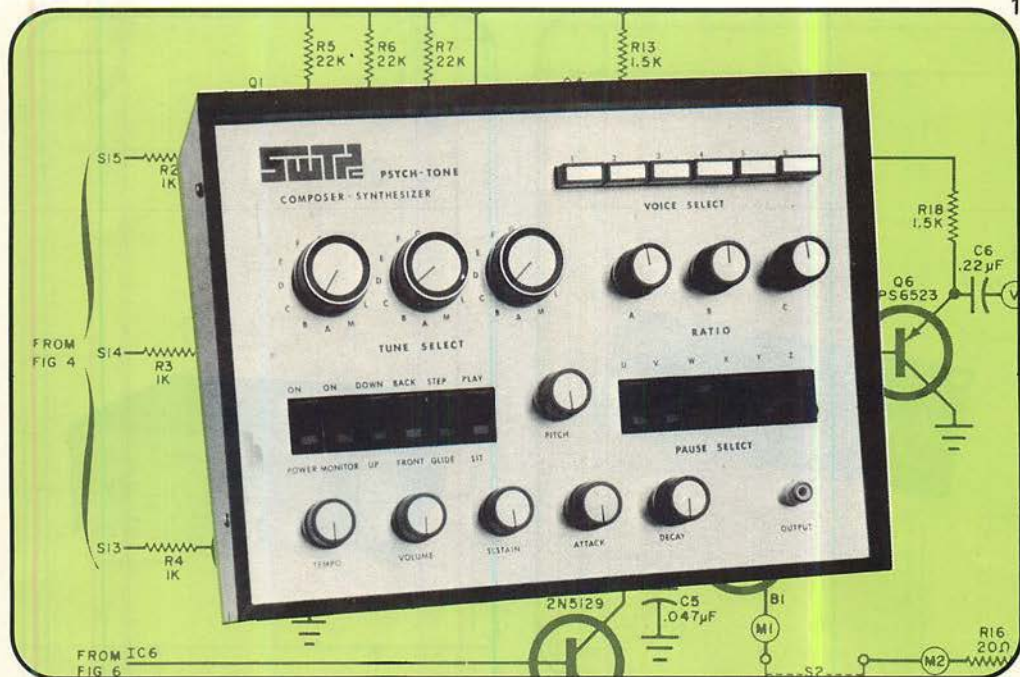

A new and unusual approach to music synthesis. The sounds produced by the Psych-Tone are modern — to say the very least — and operation is simple.

Basically a "pseudo random" sequence generator which operates as a tune computer, the Psych-Tone allows variation of the tempo, voicing, selection of pauses and tone shaping. The internal digital computer may be set for 1728 different 63 note sequences. These may be selected and combined with any of 63 pause combinations to produce 108,864 different melodic lines. These may be played at almost any tempo, pitch, or volume; backward or forward. Six different voices are provided and the user has full control of the attack, sustain and decay functions.

The wide flexibility of the controls makes possible sounds like a piano, violin, bagpipe, or something never heard before. On occasion, the music may sound familiar, but it is more likely to have science-fiction flavor with many wild tonal sequences.

The Psych-Tone has an internal monitor speaker, but preferably, it should be used with an external amplifier having reverb and tremolo to get the most exotic sounds.

PSY Psych-Tone kit complete with black vinyl covered case - 7"x10"x5" High - Not for beginners - Complex wiring involved.

Shipping Weight 6 lbs. \$53.15

PSYCH-TONE

A PROGRAMMABLE MELODY
SYNTHESIZER

WITH 28 CONTROLS AND A 63 NOTE
MEMORY

Warning: Operation of this device in the presence of anyone over thirty may be hazardous to your health.



Southwest Technical Products Corporation, 219 W. Rhapsody, San Antonio, Texas

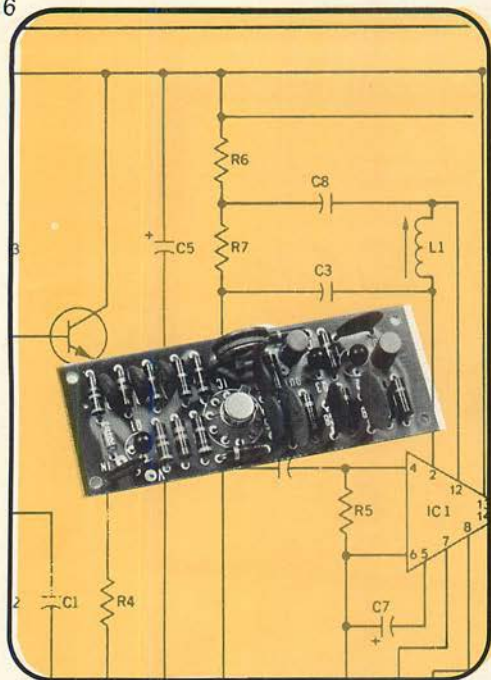

SCA MULTIPLEX ADAPTOR

Now get "Music Only" FM Programs

Sensational new approach to detection of the multiplexed subcarrier used by many FM stations. This adaptor may be used with any FM radio or tuner. New "phaselocked loop" integrated circuit provides both the filtering and FM detector needed to receive these broadcasts. Our kit is complete with instructions for installing the adaptor in your tuner. Power required is 12.0 Volts DC @ Ma.

Use of the "phase locked loop" system results in a circuit with superior rejection of unwanted interfering signals, better fidelity and requires no inductors, or tuned circuits.

Note - Commercial use of this circuit for background music systems is illegal.

PLL - 1 Shipping Weight 2 lbs. \$14.50

Now available with built-in squelch circuit to eliminate noise if your station drops its SCA carrier.

PLLS - Shipping Weight 2 lbs. \$19.50

PLLAS - Assembled -
Shipping Weight 2 lbs. \$29.95

SPECIFICATIONS

Input Impedance 5 Meg. Ohms

Output Level 1.0 Volt

Detection Range 50-80 KHz

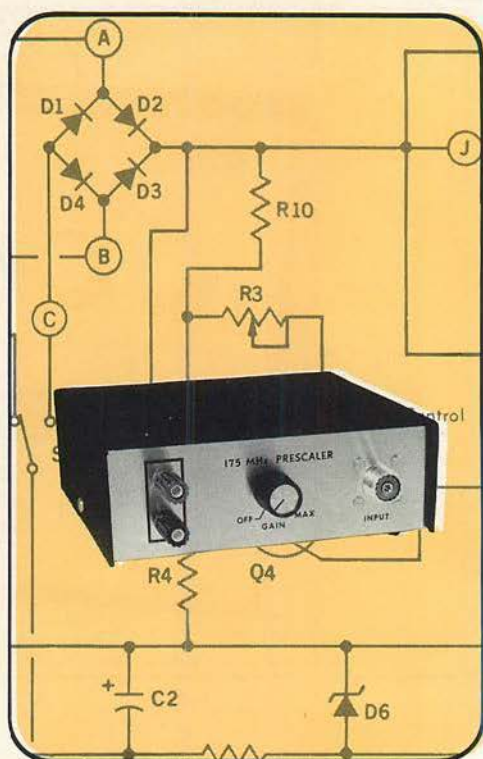

175 MHz FREQUENCY SCALER

÷ 10 SCALING 2 to 175 MHz
UP TO 10 VOLTS RMS INPUT
ECL CIRCUITS-TTL OUTPUT
USE WITH ANY COUNTER

Extend the range of your FC-2 or any other counter to 175 MHz. This prescaler uses emitter coupled logic circuits that will count directly to 175 MHz. Used in combination with any frequency counter, this will allow you to measure CB, Ham and 2-way frequencies into the VHF ranges.

Prescaler and its power supply are in a 6x5½x2 metal case with vinyl covered top. Input sensitivity is 0.25 Volts RMS at 2 MHz decreasing to 0.5 Volts at 175 MHz. Output is 3.5 Volts for matching to TTL logic. This kit does the same job as similar equipment costing three times our price.

177 Prescaler Kit. 3 lbs. \$33.75



Southwest Technical Products Corporation, 219 W. Rhapsody, San Antonio, Texas

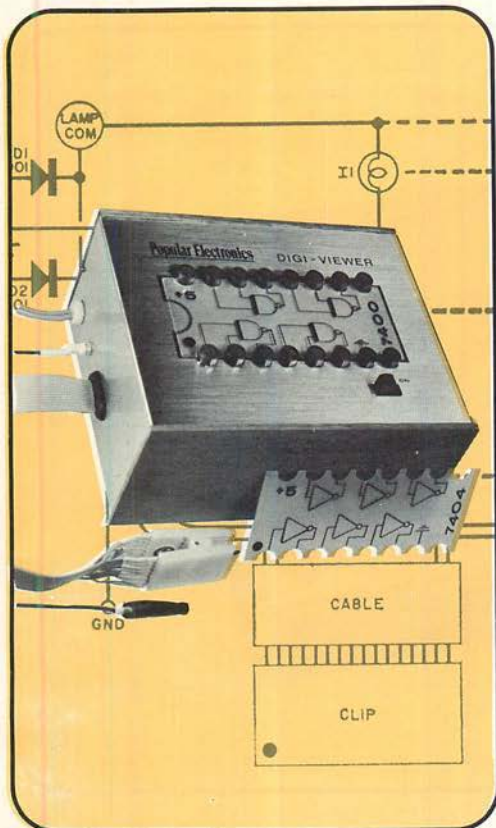

DIGI-VIEWER

AUTOMATIC - IN OPERATION TESTING OF DIGITAL INTEGRATED CIRCUITS

In-circuit dynamic testing of integrated circuits is now simple and inexpensive with the Digi-Viewer. The instrument consists of 16 lamps and a special clip which allows quick and easy connection to the pins. The lamps visually show whether the voltage at each pin is over, or under 1.4 Volts. Overlays are provided for all popular circuits, making it possible to see at a glance what is happening at the various pins of the entire package simultaneously.

VU Kit of all parts including case, clip and sheet of most used overlays -
Shipping Weight 4 lbs. \$19.86

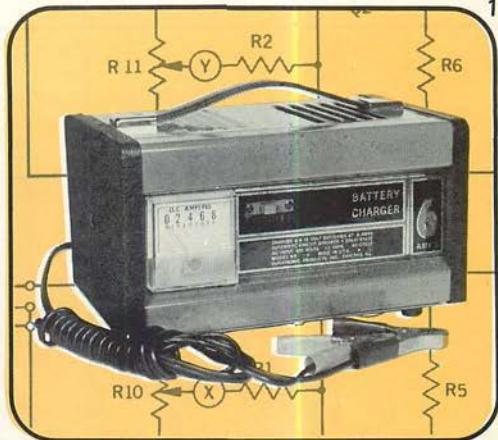

BATTERY CHARGER 6 OR 10 AMP

KEEPS AUTO, BOAT, OR MOTOR-
CYCLE BATTERYS AT PEAK POWER

AUTOMATIC RESET CIRCUIT
BREAKER 6 or 12 VOLT

ALL WIRES READY TO USE - NO
SOLDERING REQUIRED IN KIT

This high output battery charger is ideal for keeping those boat, cycle, snowmobile, truck and car batteries up to full charge. Both models feature all steel vented cases, 6 foot power and charging cables, insulated copper battery clamps, automatic circuit breakers riveted in place vinyl handles, large easy to read meter, high output transformers and full-wave selenium rectifiers. The kit may be assembled in less than an hour with only a screwdriver. All wires in the kits are supplied with push-on terminals and clips already attached at the factory. Easy step-by-step instructions supplied for assembly. Both models, 6 or 10 Amp, will supply up to 50% more than rated output on initial charging surge; tapers up 2 to 3 Amps as the battery comes up to full charge. Case is red with black crackle end plates.

# B-6	6 Amp Battery Charger Kit -	
	Shipping Weight 10 lbs.	\$14.95
# B-6A	Assembled 6 Amp Charger -	
	Shipping Weight 10 lbs.	\$17.50
# B-10	10 Amp Battery Charger Kit	
	Shipping Weight 12 lbs.	\$19.95
# B-10A	Assembled 10 Amp Charger	
	Shipping Weight 12 lbs.	\$23.50



Southwest Technical Products Corporation, 219 W. Rhapsody, San Antonio, Texas

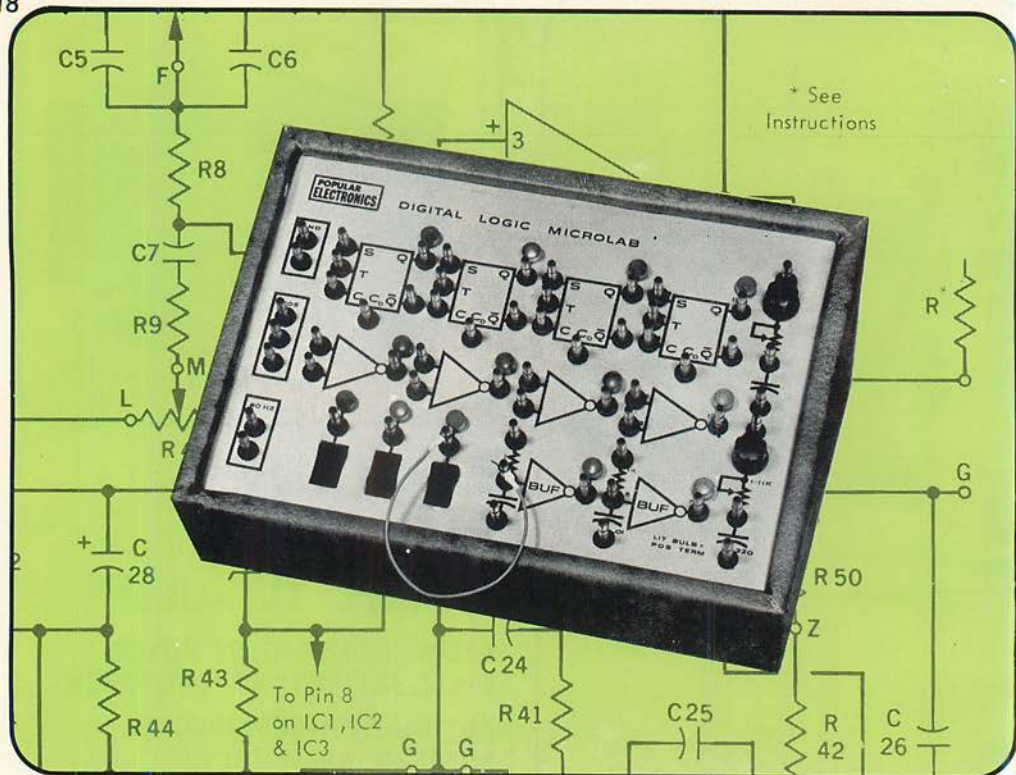

The MicroLab makes it possible to quickly check, or understand a variety of digital circuits. The MicroLab includes four flip-flops, four gates, two buffers and three bounceless switch circuits that can be used to make hundreds of basic logic circuits. Each logic block has a light to indicate its state. Three types of input signals are available on the panel. Connections are made with simple clip-on leads that require no soldering and are easy to attach and remove. The entire instrument is "goof proof". No possible combination of connections, no matter how wrong, can damage the circuits.

The kit is complete with AC power supply and vinyl covered outer case. An ideal companion for the MicroLab is available. Don Lancaster's "RTL Cookbook" presents basic digital logic in an easy to understand, non-mathematical manner. With this book and the MicroLab anyone can have a good understanding of digital circuits in a very short time.

DLM Complete Kit as shown -
Shipping Weight 4 lbs.\$29.95
"RTL Cookbook" by Don Lancaster
Shipping Weight 1 lb.\$5.50
Lab Manual (28 Experiments)\$1.95

DIGITAL LOGIC MICROLAB

LEARN HOW DIGITAL CIRCUITS
WORK

VERIFY DESIGNS QUICKLY

EXCELLENT TEACHING AID



Southwest Technical Products Corporation, 219 W. Rhapsody, San Antonio, Texas

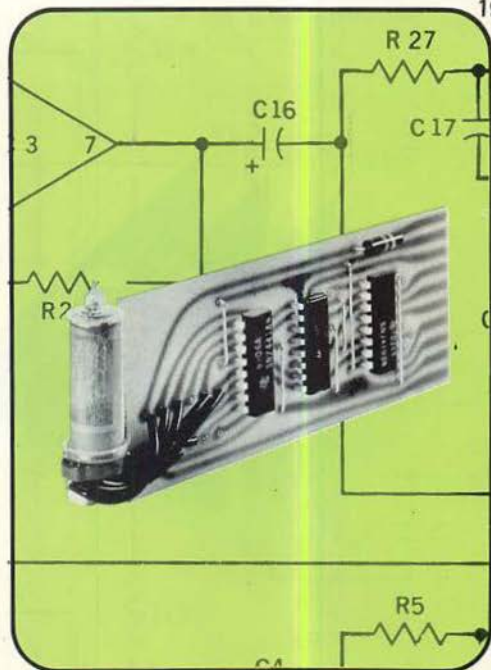
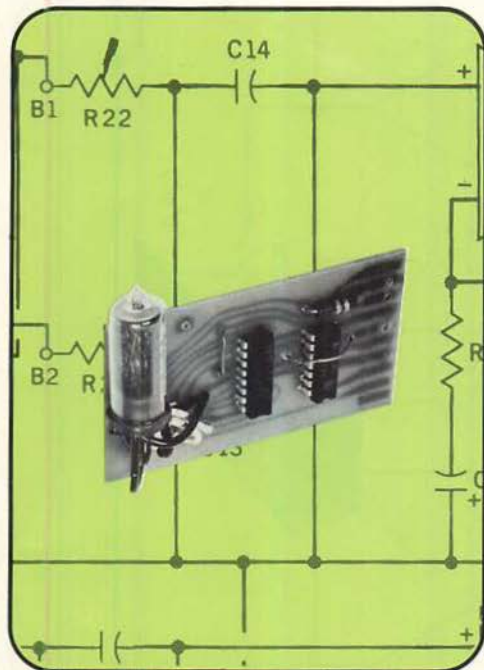

NIXIE COUNTERS

The most complete line of counter kits available. Now you can build your own custom digital instruments with any features and any type readout you prefer. Check the new lower prices on these all TTL Series 74 circuits.

NIXIE type—Our most economical counter. Counts 0 to 9 and resets. Complete with circuit board 7490, 7441, readout tube, wire solder, etc.

Standard TTL logic levels—counting speeds typically 20 MHz. Requires +200 Volts DC @ 4 Ma. and +5 Volts DC @ 50 Ma.

NX. **Decade Counter Kit** - 5 oz. \$9.95

NIXIE type—Modulo 6—Same features as above counter, but counts 0 to 5 and resets. Complete with circuit board 7492, 7441, readout tube, wire, solder etc. Needed to build timers, clocks, etc.

Logic Levels & power requirements same as # Nx-6. **Modulo 6 Counter Kit** - 5 oz. \$9.95

NIXIE type with storage. Addition of storage circuit to our standard counter makes the readout more pleasant to use. The counter will display the previous count until a "strobe" pulse is applied to change to the next reading. This results in a continuous nonblinking display. Complete with 7490, 7475, 7441, circuit board, readout, wire, solder, etc. Counts 0 to 9 and resets.

Standard TTL logic levels. Requires +200 Volts DC @ 4 Ma. and +5 Volts DC @ 70 Ma.

SNx. **Decade Counter with Storage Kit** - 6 oz. \$12.95

NIXIE type Up - down counter. Counting speeds of up to 32 MHz in either direction. —Storage—Counts any modulo from 2 to 10 —Present inputs. This counter has every feature that you might need for sophisticated instruments. The counter can either add, or subtract counts. The display changes only on command for nonblinking readout. The counter may be wired to count any modulo desired and any number may be entered in the counter before counting is begun. Complete with 74192, 7475, 7441, circuit board, readout tube, wire solder, etc.

Standard TTL logic levels. Requires +200 Volts DC @ 4 Ma and + 5 Volts DC @ 80 Ma.

Unx. **Up-Down Decade Counter Kit** - 8 oz. \$17.60



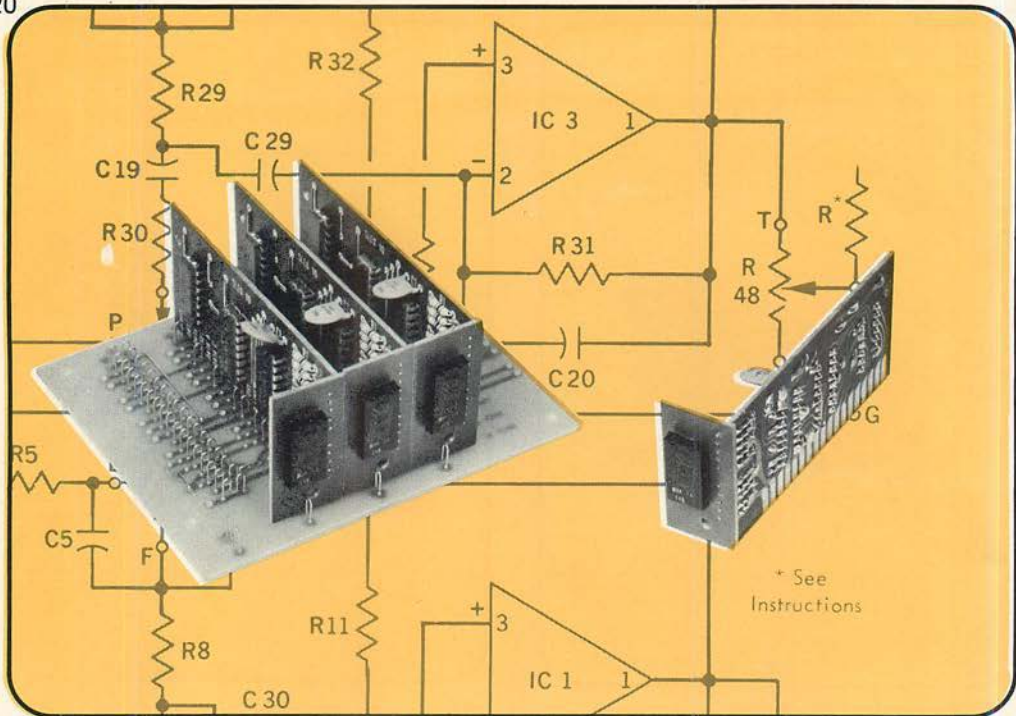

LED READOUT

LARGE MAN-1A READOUTS
PLUG-IN COUNTER CONSTRUCTION
BOTH DECADE AND MODULO 6
AVAILABLE

CHOICE OF MOTHER BOARDS
PARALLEL INPUTS & BCD OUTPUTS

Now you can build digital projects with beautiful, rugged, large size LED readouts with a minimum of problems. Our mother board system combined with plug-in readout modules makes it possible to build a readout with the type and number of digits you want with a minimum of wiring and without special mounting hardware.

The readout modules use 8200 type TTL counters. These counters have typical counting speed of 25 MHz and parallel input terminals. This makes it possible to enter a number into the counter before actual counting is begun. Digital tuning indicators and "count down" type timers must have this feature. The four line BCD output from the counter is available on the mother board if needed. The counter output is stored by a 7475 latch circuit and displayed only upon command. This provides smooth "blink free" displays. The genuine MAN-1A readout display has 0.3 inch high seven segment type pattern. Connections are provided for variable brightness and for automatic blanking of unnecessary zero's.

The mother boards are available in four digit, six digit and timer-clock arrangements. All mother boards are complete with high speed buffer circuits for the strobe and reset lines. This reduces fan-in to a maximum of two on any mother board input line. Mother board kits contain all necessary hardware for plug-in counter kits above.

SLED-10 or SLED-6 Counter Kit complete with readout (one decade), 4 oz.\$14.95
 MO-4 Mother Board Kit, 8 oz.\$4.50
 MO-6 Mother Board Kit, 8 oz.\$5.50
 TMO-7 Clock-Timer Mother Board Kit, 8 oz., \$6.00
 #196 Power Supply for above\$12.50



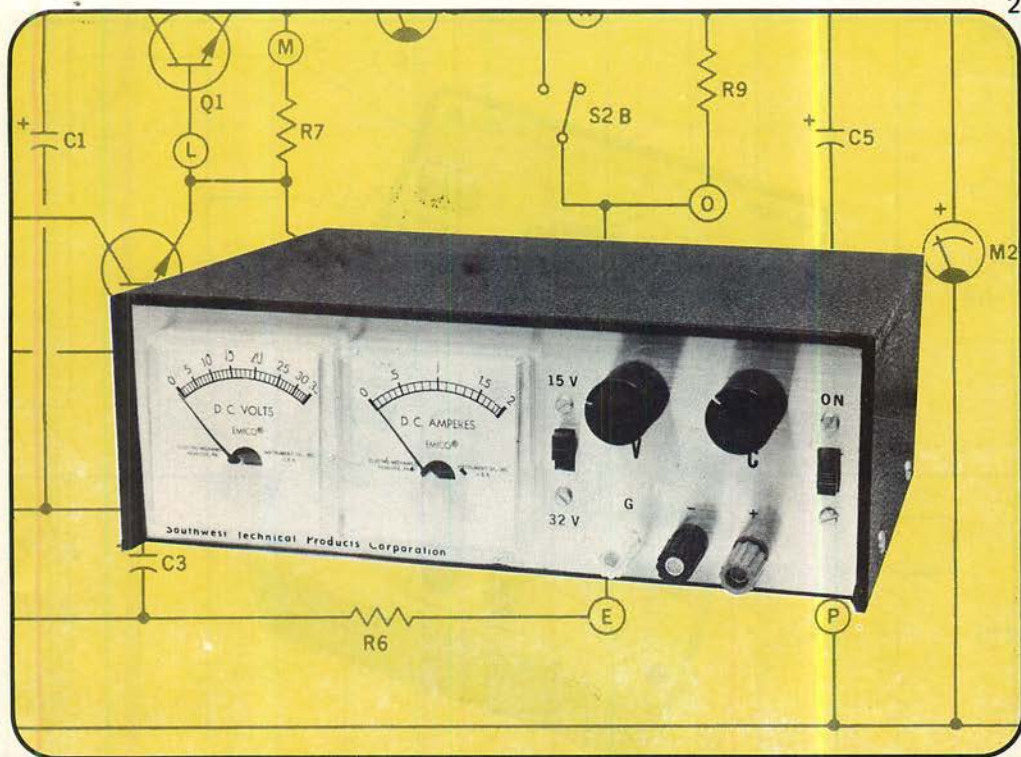

This high capacity variable voltage source not only will provide you with "rock stable" voltage for your experimental circuits, but will also provide protection against accidental shorts or circuit malfunctions. The over-current protection can be set for any amount of current that would be safe for your experiment. The supply will then "limit" current to this value or less. The power supply itself cannot be damaged by having its output leads shorted.

Cabinet is chrome finished on the inside. Front panel is our new brushed gold finish. This combined with the black vinyl covered top gives you a handsome instrument that looks far more expensive than it's actual modest cost.

143C Short-Proof Power Supply Kit
Shipping Weight 8 lbs.\$39.50

SPECIFICATIONS

Regulation1% or 0.1 Volt, whichever is greater for 0-100% load
Voltage Range 0-32 Volts, 10 mA to 2 amperes, continuously adjustable
Stability..... Less than 20-MV drift (constant ambient temperature with fixed load) over a 6-hour period
Input 105-125 Volts a.c.
Ripple 0.003% or 10 mV r.m.s. maximum

SHORT PROOF POWER SUPPLY

SAFE - ADJUSTABLE CURRENT
LIMITING CIRCUITS PROTECT YOUR
CIRCUIT AND SUPPLY FROM
DAMAGE BY EXCESSIVE CURRENT
DRAIN

0-35 VOLTS DC AT UP TO 2.0 AMPS



Southwest Technical Products Corporation, 219 W. Rhapsody, San Antonio, Texas

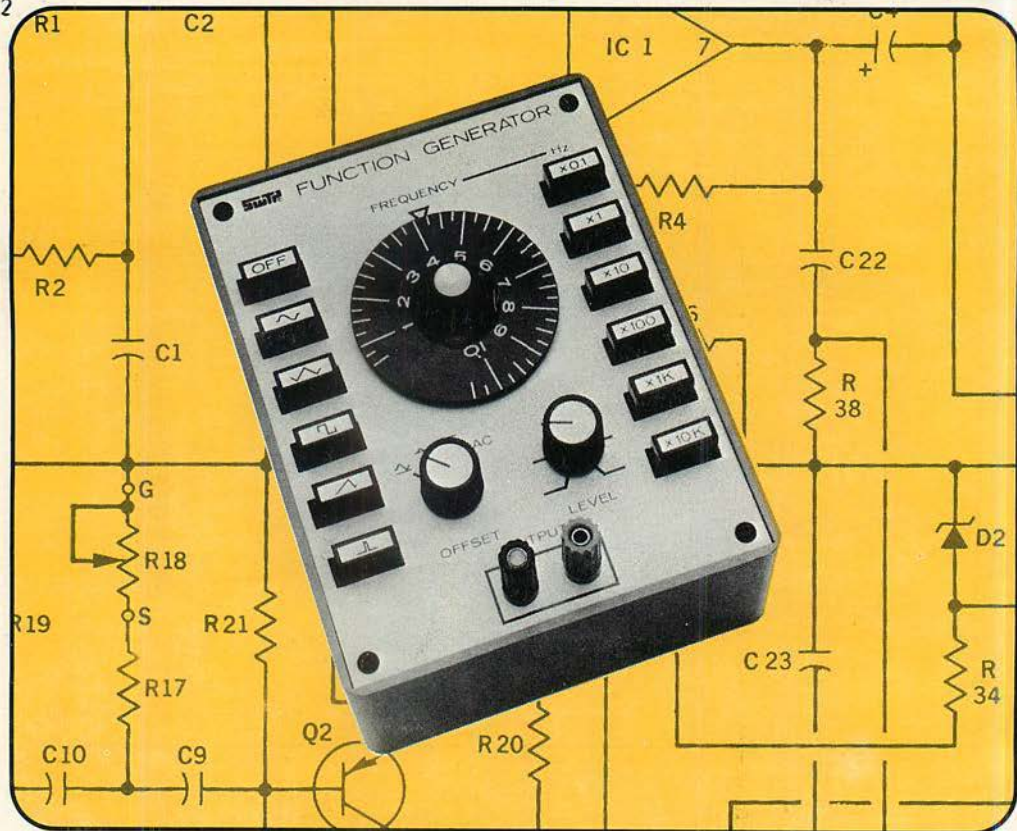

FUNCTION GENERATOR

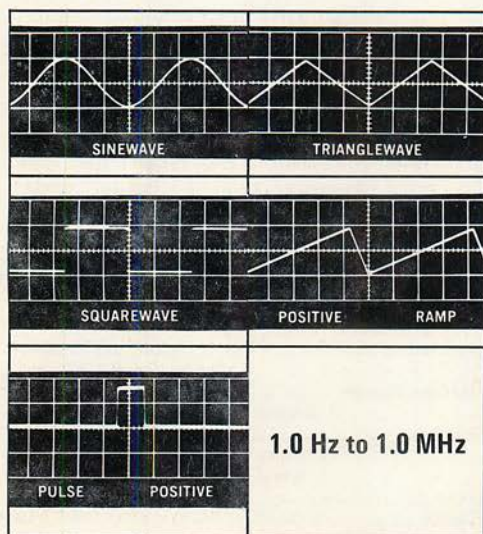

Now, thanks to IC technology, everyone can afford one of these versatile waveform generators. This is the ideal general purpose signal generator. Use it for checking audio equipment, digital circuits, sweep circuits, or anywhere you need a variety of waveforms.

Construction is very simple due to extensive use of circuit boards. Only the offset, level and frequency controls are wired. Our kit features switch selection of waveform, frequency range and type of offset. Output amplitude is constant to less than ± 1 dB on any range and with any waveform. Sine wave distortion is less than 1% from 20 to 20,000 cycles. Square wave and pulse rise times are less than 0.25 microsecond. Accuracy is 1% on the range calibrated and better than 5% on all other ranges.

The Instrument is housed in an impact plastic case for maximum drop protection. Case size $5\frac{1}{4} \times 6\frac{3}{4} \times 2\frac{1}{2}$. Power required 115 Volts AC.

#FG-2 Function Generator Kit
Shipping Weight 3 lbs. **\$39.95**



Southwest Technical Products Corporation, 219 W. Rhapsody, San Antonio, Texas

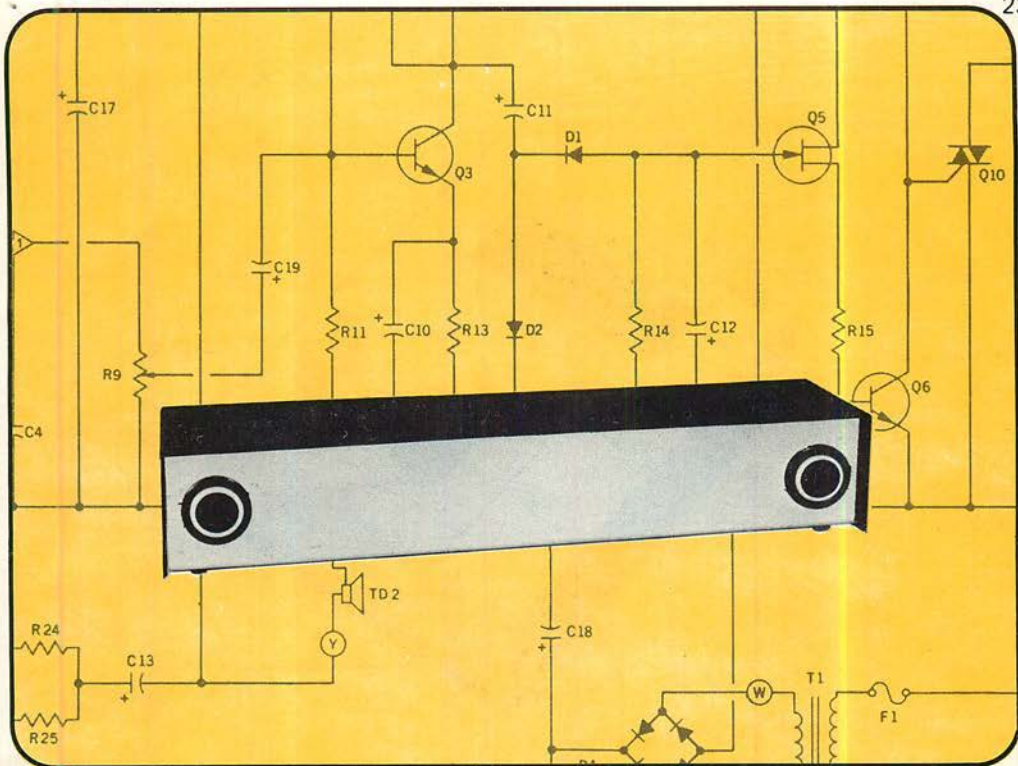

ULTRASONIC INTRUSION ALARM

EASY INSTALLATION

IMPOSSIBLE TO AVOID

AREA PROTECTION UP TO
400 SQUARE FEET

PROVEN "DOPPLER" TYPE
DETECTION

NEW FET INPUT STAGE

FET - TRIAC DRIVER

Now you can equip your home with the same type intruder alarm system used by industrial plants, banks, and the IRS. The protected area is flooded with ultrasonic sound waves. Anything moving in the sound wave field causes a change in the amount of sound reflected back to the receiver and trips the alarm. This is the same "Doppler" principle used in Highway radar.

Easy installation — simply "aim" the unit at the area to be protected, and set the sensitivity. The integrated circuit and nine transistors operate on 12 Volts, so the alarm can be used in cars and boats too. The internal AC power supply will supply up to 1 Amp to any 12 Volt alarm device that is connected to the system.

UA-2 Ultrasonic Alarm Kit.
Shipping Weight 5 lbs. \$37.25

SPECIFICATIONS

Size 13x3x2½
Operating Frequency 40 KHz
Area Coverage Up to 200 Sq. Feet
Controls Sensitivity and remote
reset if desired
Power Requirements 117 Volts AC
or 12 Volts DC
Outputs... 117 Volts AC or 12 Volts DC Available

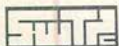

Southwest Technical Products Corporation, 219 W. Rhapsody, San Antonio, Texas

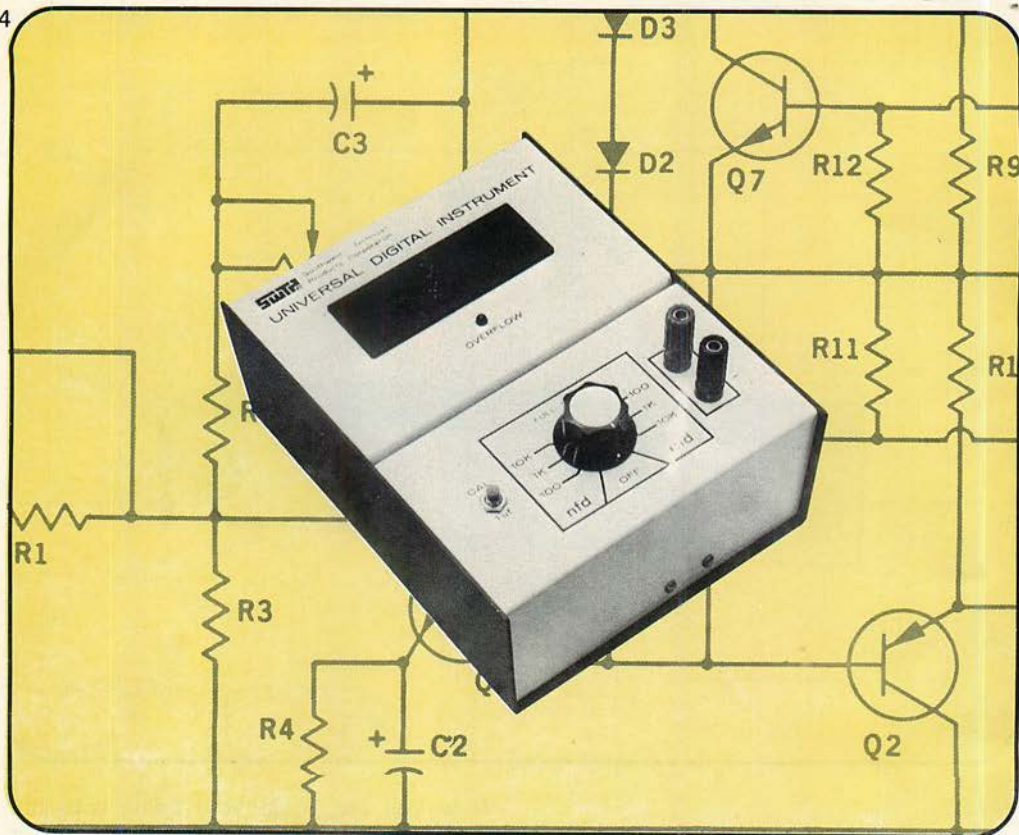

UNIVERSAL DIGITAL INSTRUMENT

The first digital system to offer a choice of battery, or AC operation. Our new digital mainframe is without question the best possible choice for those who want a digital instrument with the most versatile range of applications. This system can do more and at

less cost than any other digital instrument. You get a full four digit LED readout to begin with. Not a skimpy two digit plus over-range system as in other lost cost units. In addition to this the mainframe has its own .001% accurate crystal timebase and a MOS divider circuit. This means that the mainframe can supply timebase, or timing signals to the various plug-ins and simplify their circuits considerably.

The plug-in units connect to the mainframe with a chassis mounted connector making changes fast and easy. The instrument is housed in a rugged 6 x 7½ x 2½ steel case and finished with tough epoxy enamel. With this system you will be able to make many types of measurements with digital accuracy and convenience and at minimum cost. Photo shows the mainframe and capacity plug-in unit described on the opposite page.

Universal Digital Instrument—(less any plug-in units)
UDI-1 4 lbs.\$59.95



Southwest Technical Products Corporation, 219 W. Rhapsody, San Antonio, Texas

FREQUENCY COUNTER

Frequency counter plug-in for the Universal Digital Instrument. This plug-in allows you to measure frequency or pulse rate from 0.1 Hz to 20 MHz. with .001% accuracy (± 1 count). Sensitivity is 100 Mv. up to 2 MHz and 500 Mv maximum over 2 MHz. Input impedance is 1 Meg Ohm shunted by 20 pf. An external trigger level control is provided so that the trigger level may be set correctly on complex waveforms.

Frequency Counter Plug-in Kit—2½ lbs. #FC-3\$24.95

TIME BASE

The time base plug-in for the Universal Digital Instrument is a good example of the simple handy plug-in units that can be offered due to our unique mainframe divider circuit. This plug-in provides a source for precision symmetrical square waves at any frequency from 1 Hz to 1 MHz. Use it for a scope vibrator, test equipment range adjustments, timing signals or any other type application that requires a stable crystal controlled frequency reference.

Time Base Plug-in Kit—2½ lbs. #TB-3\$11.25

CAPACITY —

Another very handy instrument to have around the shop. The capacity plug-in lets you measure the capacity of any capacitor from 10 pf to 10,000 mfd quickly and exactly. The circuit uses a safe low voltage for testing and a discharge system of measurement. This prevents any possible damage to low voltage capacitors and eliminates any effects that leakage might have on accuracy.

Capacity Plug-in Kit—2½ lbs. #UC-1\$24.95

TIME PERIOD

The electronic stop watch plug-in. This handy instrument lets you time the duration of events, or the time between two events with .01% accuracy. The plug-in will time events as short as 10 microseconds, or as long as a million seconds. You can use it for high speed applications such as shutter testing on cameras, or bullet velocity, or you can use it for low speed applications such as slot car races, track and field events, etc.

Time Period Plug-in Kit—2½ lbs. #TM-3\$14.95

MORE TO COME

We will soon be ready to announce several more plug-in units for our new Universal Digital Instrument. In the next few months, we will have a Voltmeter-Ohmmeter, Clock-Timer, Ph Meter and many more. We intend to make this the most versatile digital instrument anywhere.



Dear Electronic Kit Builder:

As we near the end of our ninth year in the electronic kit business, all of us here would like to thank you out there for your support and encouragement. We appreciate all the suggestions and comments on our products. We appreciate your patience when we have had to backorder kits and when we have messed up orders, or packed incorrect parts. I suppose being human, that we will continue to make a few mistakes now and then, but we will continue to try and keep it down.

In this catalog we are introducing our new "Tiger .01" #207/A amplifier. This amplifier uses a new push-pull cross-coupled driver system that we think will be a milestone in amplifier development. It will be very interesting to see what the people who test Hi-Fi equipment have to say about this one. We ourselves found the results rather hard to believe, but finally had to conclude that we were not doing anything wrong and that the analyzers were in proper working order. For the first time that we know anything about we have on our hands an amplifier circuit that produces less IM than harmonic distortion. Everyone seems to agree that the IM figure is more significant and that it correlates better with what your ears tell you about the sound. The intermodulation distortion (IM) of this amplifier is less than .01% up to the rated output of 60 Watts. This is ten times better than a number of amplifiers that are highly regarded and considered as good as anything available on the market. It is at least 100 times lower in distortion than many of the so called Hi-Fi amplifiers that brag about having 1% distortion figures.

"Tiger .01" is available in a neat little package that may be expanded to either a stereo, or quad system by simply changing the mounting base and buying the additional amplifiers to add into the system. Four of these will fit a standard 19 inch relay rack perfectly. This amplifier comes with a perf metal cover, output level meter on the front and many other delux features as standard items in the kit.

The #198/A preamp also uses our new cross-coupled push-pull circuit for it's gain modules. This is the only popular price preamp available that features switch gain control steps. This insures an exact, known setting each time the control is used and also insures that the output is truly flat when no tone control switches are depressed. The circuit is built using a "mother board" system that eliminates much wiring that would otherwise be necessary. A very minimum of wiring is needed once the circuit boards are assembled and soldered. This makes what is a quite complex circuit easy enough for even beginners to assemble.

We are proud of the quality of our parts and engineering. If you do not agree that you have a bargain when you receive your kit, we will happily refund your money upon return of the kit in its original condition.

D. Meyer

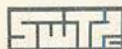

TRANSISTORS

2N3055	\$2.05
2N3528	1.63
2N3877	.47
2N4400	.60
2N4402	.60
2N4870	.75
2N4871	.68
2N4919	1.90
2N4922	1.48
2N5087	0.81
2N5129	.25
2N5139	.22
2N5210	.72
40409	1.14
40410	1.32
40668	1.58
L148B (2N5777)	\$1.45
MJ802	4.86
MJ4502	5.26
MJE2955	2.90
MJE3055	1.50
MPS3638	.45
MPS6521	.90
MPS6523	.97
MPS6566	.57
MPU131	.79
SS1122	1.60
SS1123	1.35
TIS43	1.02
TIS58	.62

INTEGRATED CIRCUITS

SP321A	\$2.48
SP380A	1.34
SP322B	2.75
MC717P	1.08
MC723P	1.35
MC724P	1.08
MC723P	1.35
MC724P	1.08
MC785P	1.25
MC789P	1.08
MC791P	2.35
MC799P	1.08
7400	.59

7402	.59
7404	.71
7441	3.25
7447	3.55
7473	1.18
7475	2.05
7476	1.30
7490	2.30
7492	2.30
74192	4.35
MC1303L	2.20
NE565A	4.35
NE540K	4.50
N5111A	2.65
N5558V	1.75
N8280A	2.10
N8288A	2.10
ECL 9528	5.60
7406	1.75
7493	2.30
LM311	4.75

DIODES AND RECTIFIERS

Germanium diodes	\$.15
VS-148 2 Amp Bridge	1.00
3.3 V zener (IN4728)	.50
3.9 V zener (IN4730)	.50
4.7 V zener (IN4732)	.50
5.6 V zener (IN4734)	.50
10 V zener (IN4740)	.50
24 V zener (IN4749)	.50
27 V zener (IN4750)	.50
36 V zener (IN4753)	.50
IN914 Silicon diode	.35
IN3754 Silicon diode	.32
IN5060 Rectifier - 1 Amp	.56
IN5624(CA-15) Rectifier - 3 Amp	.68
40583 - Trigger diode	.61

MISC.

B5750-Nixie Readout	\$6.75
ZM-1000 Nixie Readout	5.75
Socket (AM-1000) for 2m-1000	.60
MFT-110 Flash Tube	3.50
MAN-1A Readout	10.75

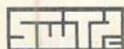

COMPUTERMATIC ALARM

FULLY AUTOMATIC - JUST TURN A KEY

PROFESSIONAL TYPE EQUIPMENT

THE ULTIMATE IN SWITCH & TAPE SYSTEMS

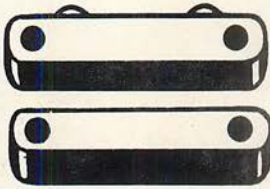

MAGNETIC SWITCHES

SIREN - 115 Volt AC motor driven. Suitable for outdoor installation. Very high sound output level.

SEE. Shipping weight 3 lbs. . . . \$15.95

MAGNETIC SWITCHES - for doors, or windows. Operate with up to 1/2 inch gap between switch and magnet. Potted reed type switch cannot be damaged by moisture, or corrode. Magnet will operate switch from any side. 2 3/15 x 1/2 x 1/2.

REE \$2.35 ea.

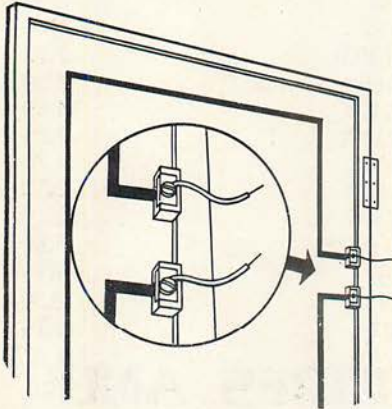

LEAD WINDOW FOIL

LEAD WINDOW FOIL - 3/8 wide - .0008 thick. Protects windows from being used to gain entrance. Lead foil will break and trip your alarm if the glass cracks. Blocks simplify connecting to the window tape.

Lead Tape - 1 lb. spool \$2.55
Take-off Blocks25

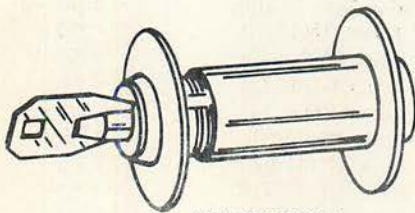

SHUNT LOCKS

SHUNT LOCKS - with sleeve and two washers. Make it possible to enter a protected area without tripping the alarm. Furnished with two round type keys. These locks are much more difficult to pick than flat key types.

SSL \$5.50 ea.



UNDERDOME BELL

UNDERDOME BELL - 8 inch, 6 Volt DC bell with heavy gauge steel gong. This bell will operate directly from our No. CA or No. UA-2 alarm systems. Will operate from standby battery if power line is cut.

UDB. Shipping Weight 6 lbs. . . . \$11.25



A woman with long dark hair, wearing a bright red dress and red high-heeled shoes, stands next to a wall with a vertical wood-grain pattern. She is smiling and looking towards the camera. Her right hand is on a square, light-colored panel mounted on the wall, which has a keyhole and some small indicators. The floor is covered in a shaggy, light-colored carpet.

The most automatic and easy to use alarm system yet built. New digital integrated circuits as used in computers now make it possible to provide you with the ultimate in convenience. The control system uses a "solid, reliable" tape and switch protection system. To use this automatic alarm you simply insert the key and turn the system ON. If the protection loop is okay and all protected doors are closed, the green light goes on and you know that the system is armed. You may now go out ANY of the protected doors. The digital circuit counts "two" and prepares the circuit to trip the alarm on the next opening of the protection loop, all indicator lights go off. When any protected door is next opened, or window tape broken, the circuit trips the alarm and locks itself into this condition. You have up to 60 seconds to insert your key in the switch-lock and turn off the alarm. The amount of delay is adjustable from 5 to 60 seconds. If the system is not turned off with the key, the bell, light, siren, or whatever is used; goes on when the delay timer runs out.

CA Alarm Kit -
Shipping Weight 5 lbs. \$19.50